

BELLAGIO-B-12

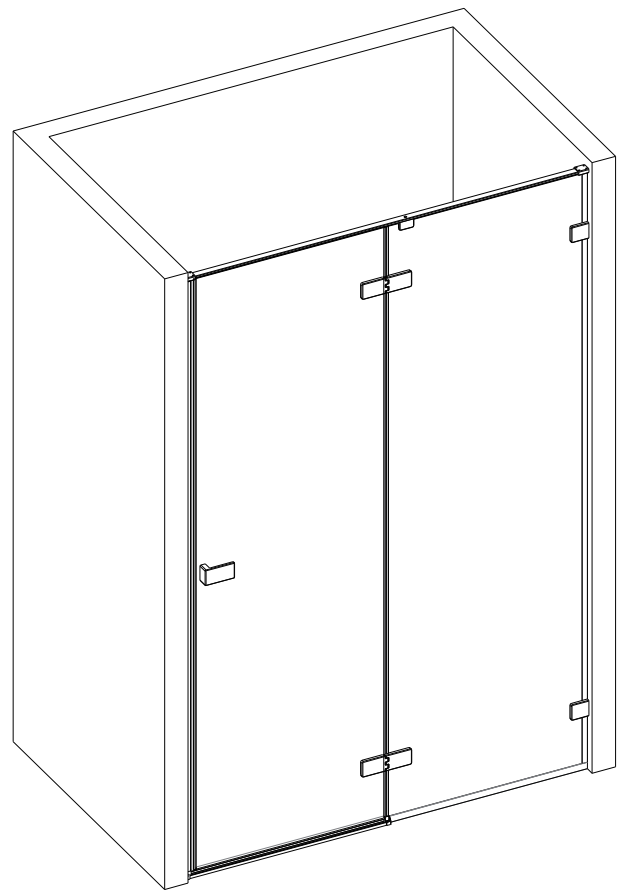
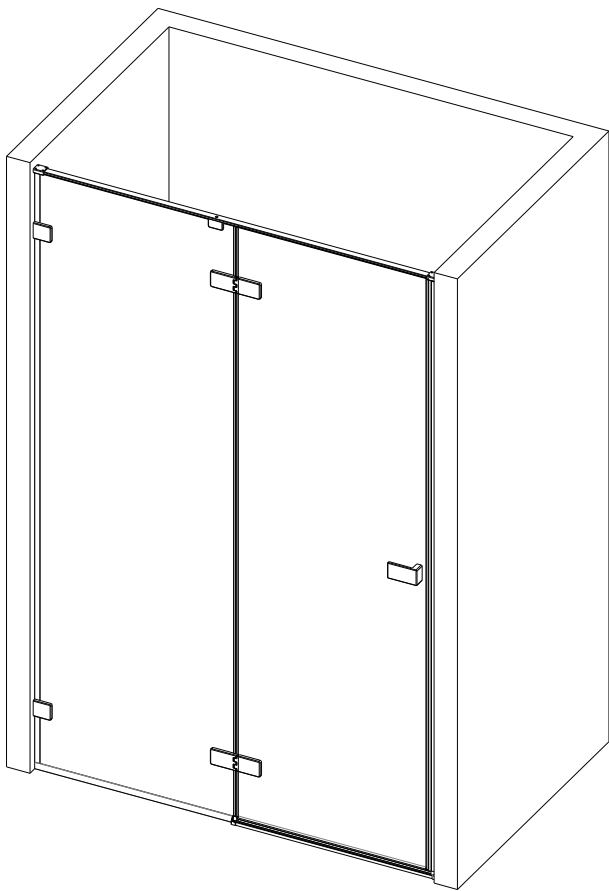

■ Общая информация

Пожалуйста, внимательно ознакомьтесь с изделием сразу же после получения на предмет отсутствия упаковки/деталей или наличия производственной неисправности. Повреждение, о котором сообщается позже, не может быть принято. Обращайтесь с изделием с осторожностью, избегая ударов и ударной нагрузки со всех сторон и краёв стекла.

Примечание: закаленное стекло не может быть повторно переработано.

■ Монтаж

Перед началом установки внимательно прочитайте эти инструкции.

Убедитесь, что поддон для душа установлен на ровном полу. Особое внимание следует уделять сверлению стен, чтобы избежать повреждения скрытых труб или электрических кабелей.

Примечание: для установки душевого ограждения потребуется работа двух человек. Перед установкой удалите защитную пленку с алюминиевых профилей.

■ Установка душевого поддона

Поддон для душа должен располагаться напротив стены.

Водонепроницаемая стена или плитка должны быть установлены так, чтобы они находились сверху поддона.

■ Инструкции по уходу

После использования душевое ограждение должно быть очищено с мылом и водой. Это особенно важно в районах с жёсткой водой, где возможны отложения солей на стенках душевого ограждения. Не должны использоваться очистители с добавлением хлора, кислоты, абразивные пасты, ацетон, спирт. Стекланные очистители можно использовать, но при этом следует соблюдать осторожность. Если есть сомнения, обратитесь к поставщику данного чистящего средства.

Сохраните данную инструкцию для ухода и дополнительного обслуживания специализированными сервисами.

1



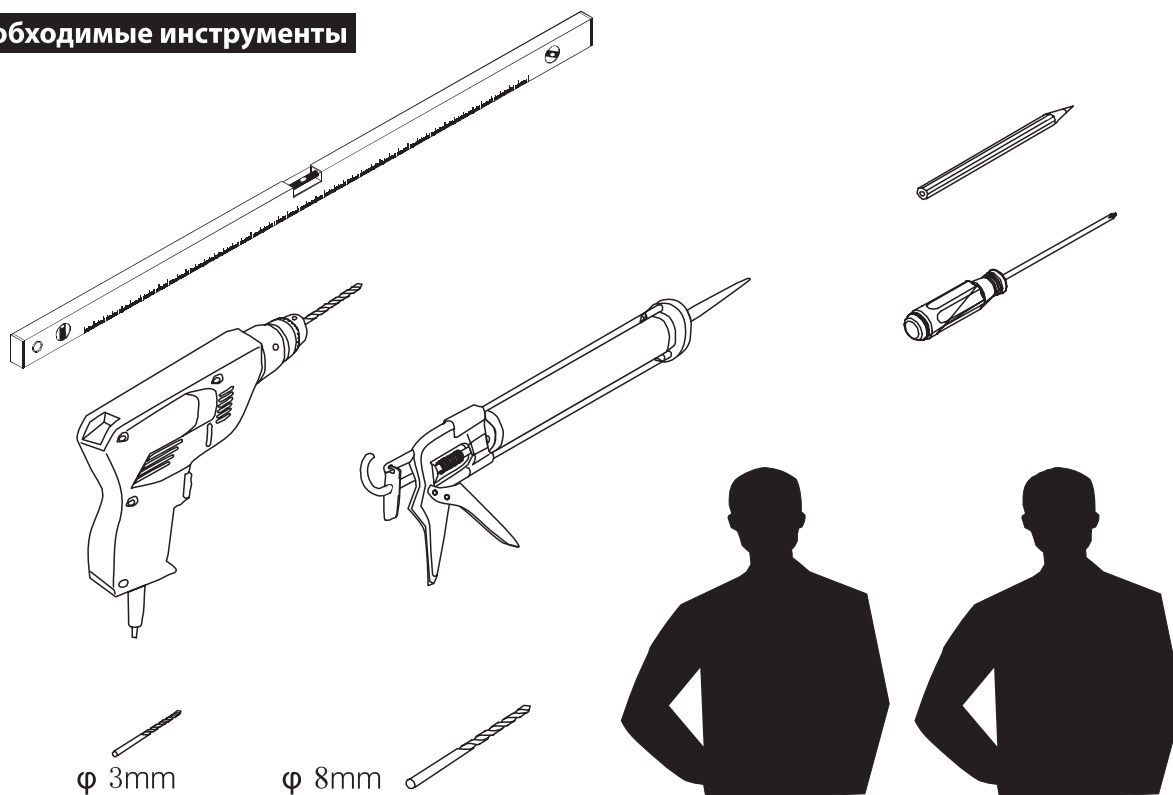





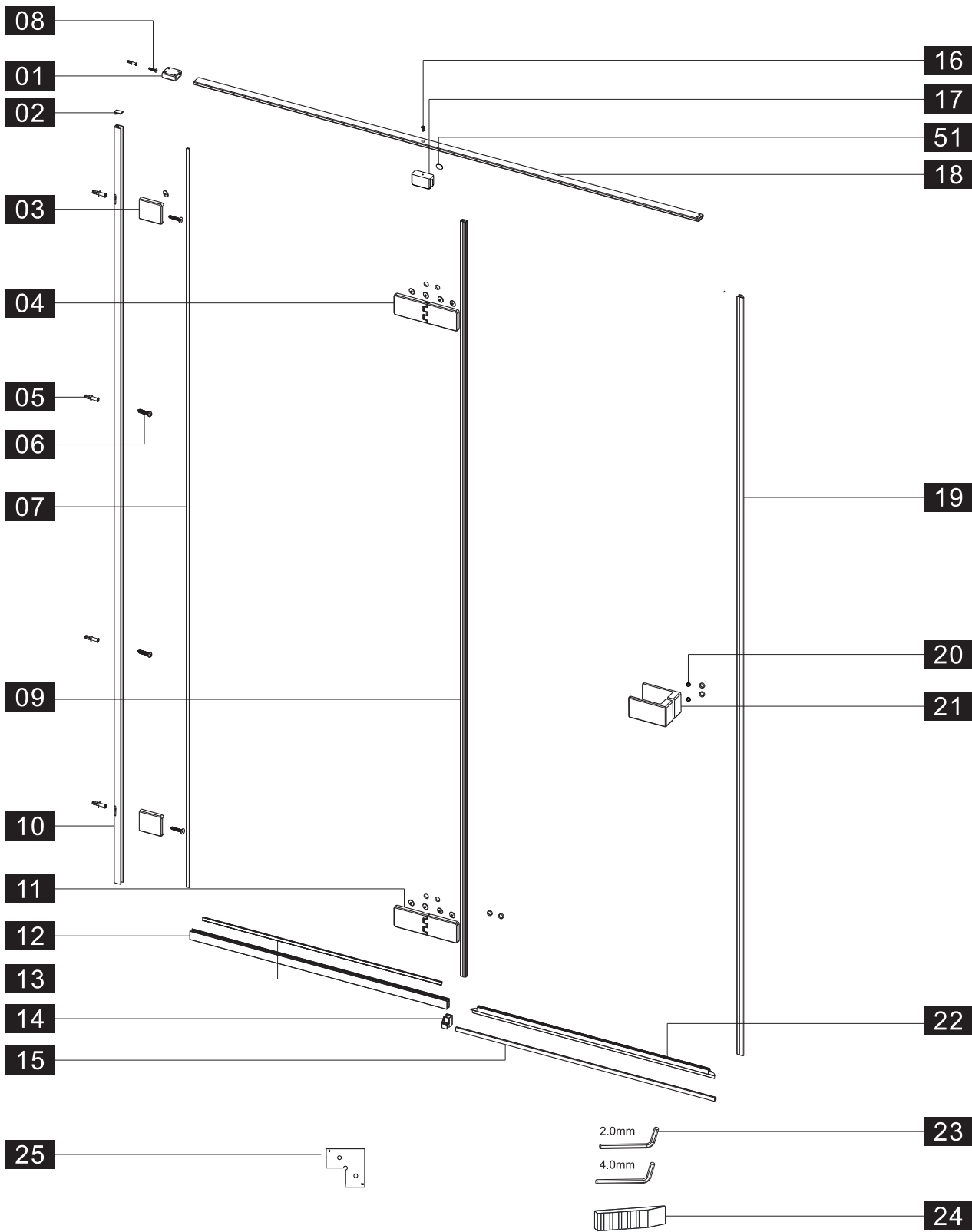

















Необходимые инструменты



Это изделие тяжёлое и требуются два человека для установки.









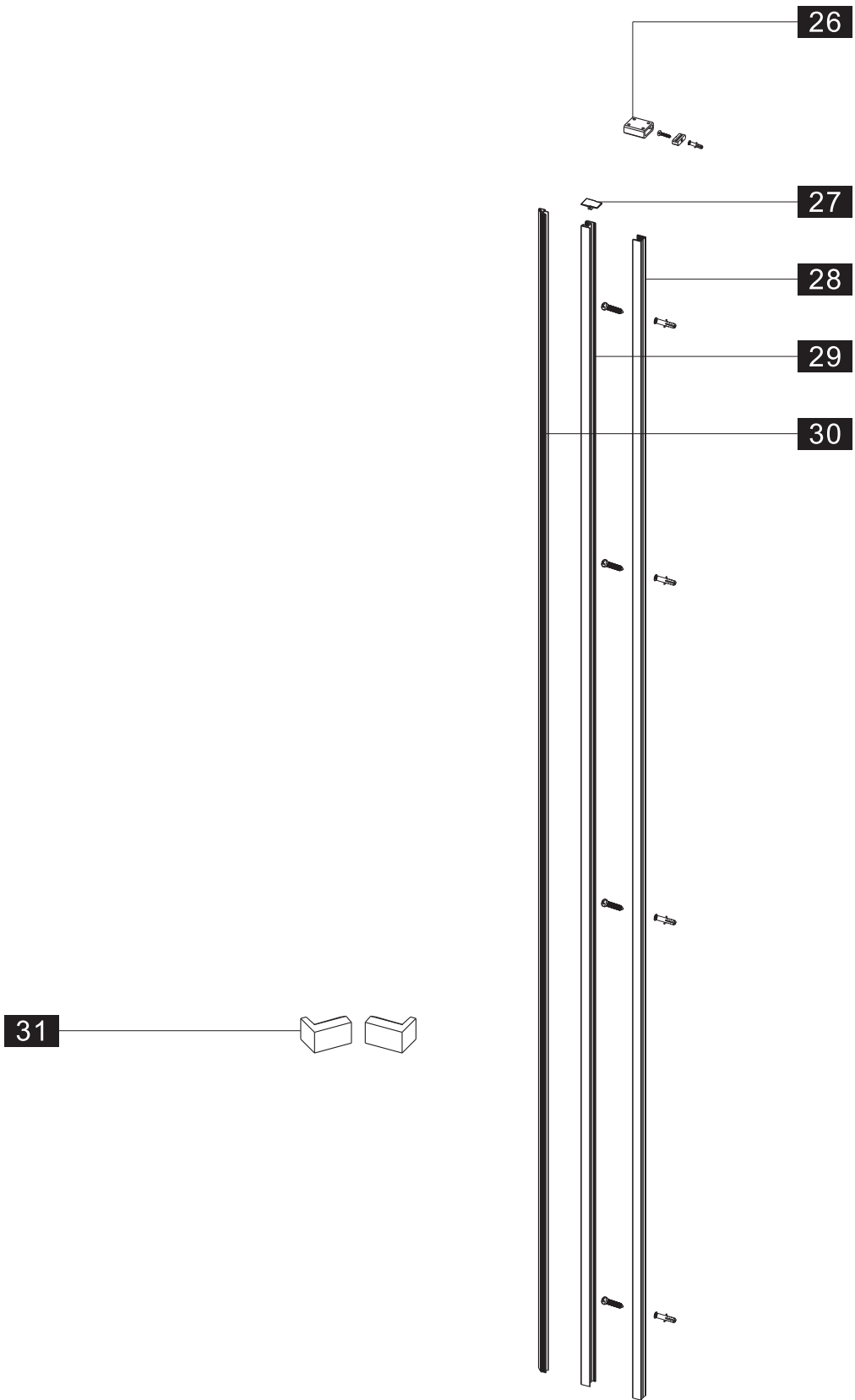



- | | | | | | | | | | | | | |
|---|---|---|---|---|---|---|---|---|--|---|---|---|
|  |  |  |  |  | 
ST4.0x30 |  | 
ST4.0x30 |  |  |  |  |  |
| 
L R |  | 
M4x8 |  |  |  |  |  |  | 
2.0mm
4.0mm |  |  |  |

 Это изделие тяжёлое и требуются два человека для установки. 



- 26 x1

- 27 x1

- 28 x1

- 29 x1

- 30 x1

- 31 x1

- 5 x5

- 6 x4

ST4.0x30
- 8 x1

ST4.0x30



Это изделие тяжёлое и требуются два человека для установки.



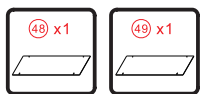
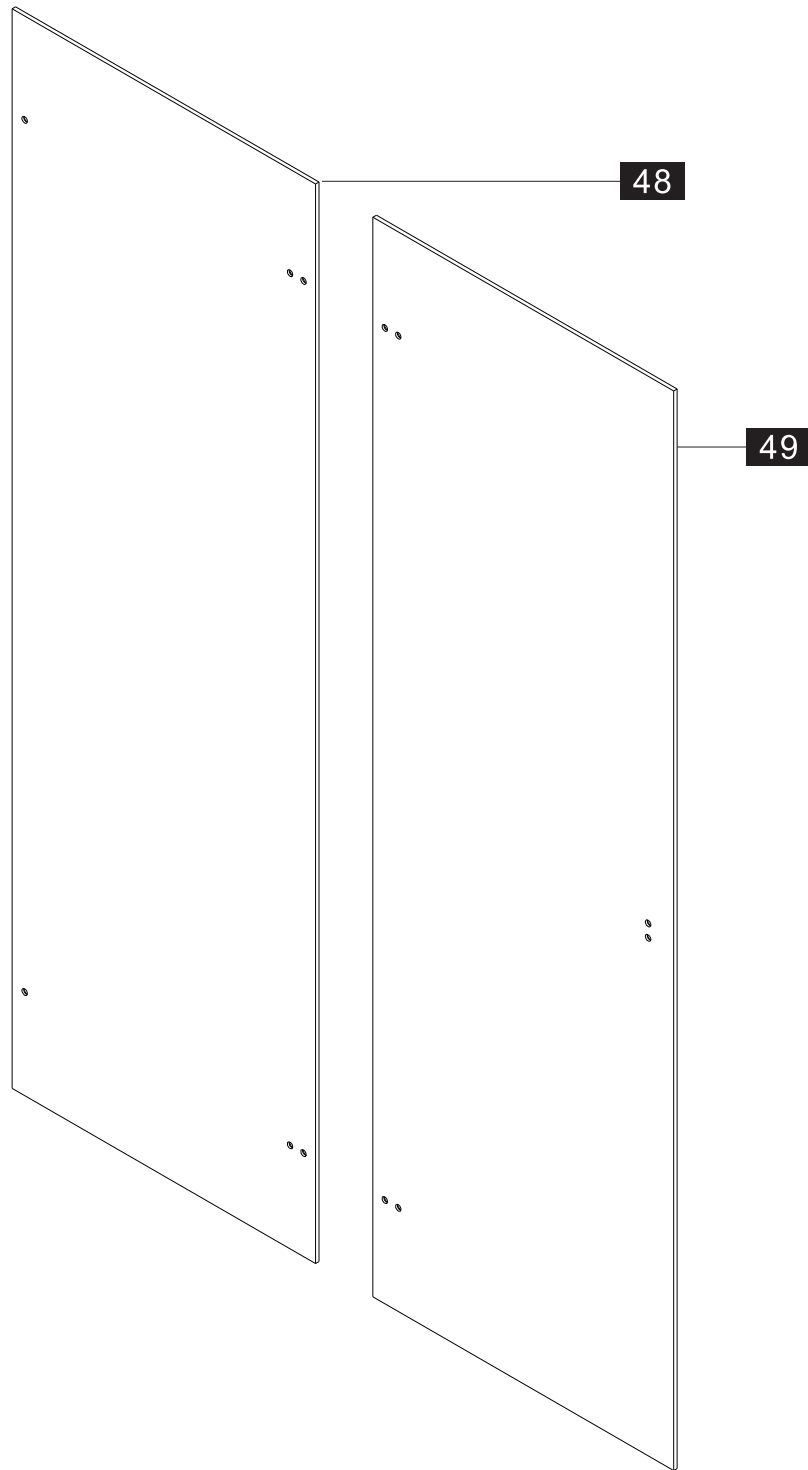

Это изделие тяжёлое и требуются два человека для установки.



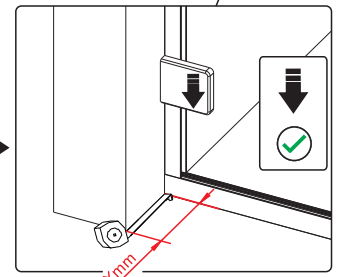
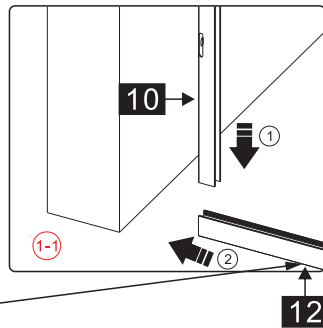
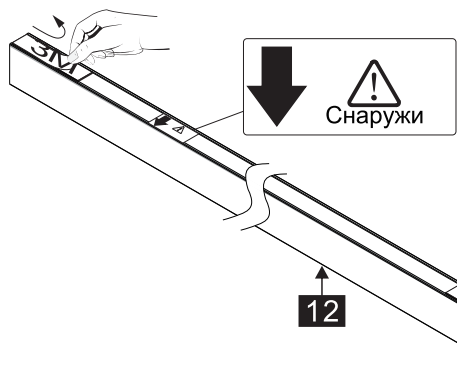
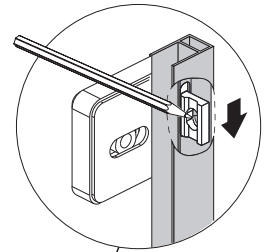
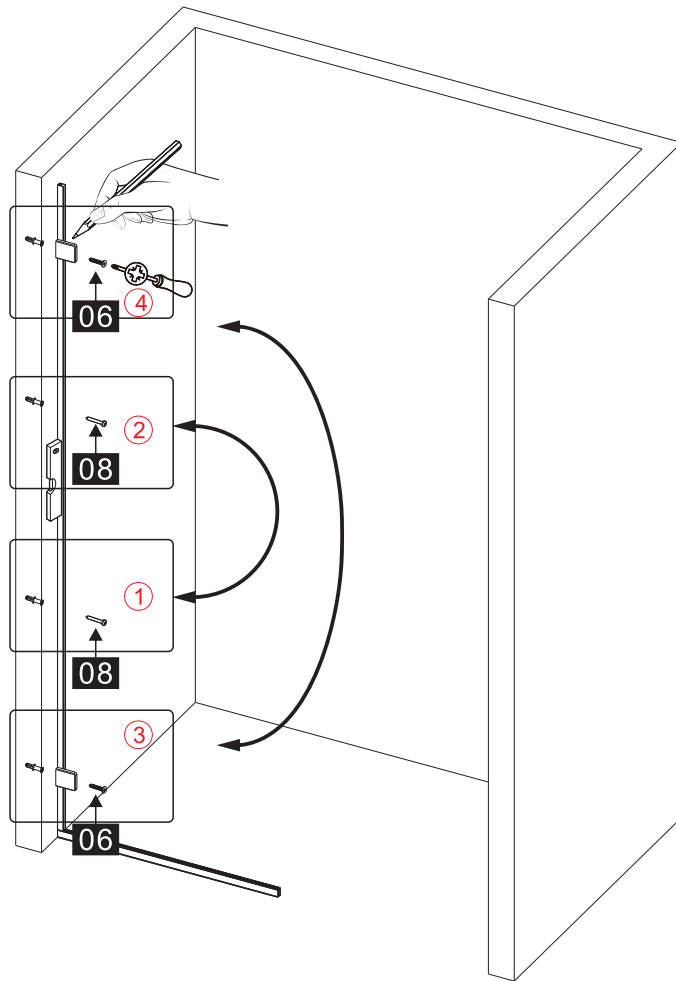

Вставьте петлю в нижнюю часть прорези и зафиксируйте положение

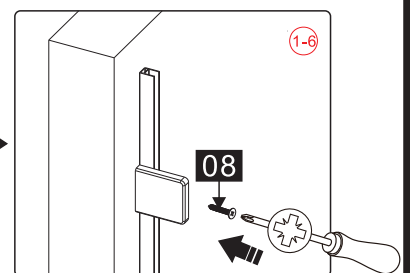
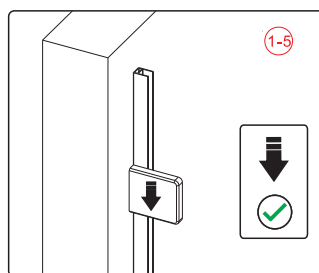
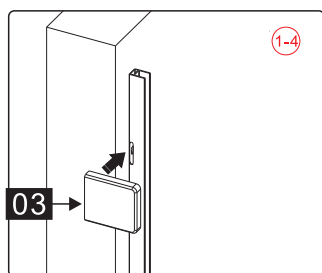
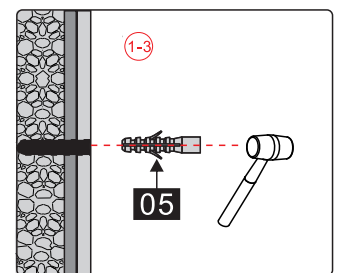
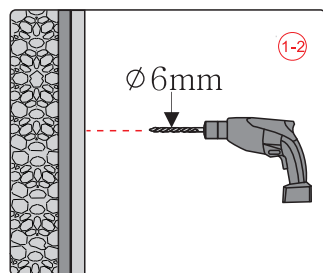
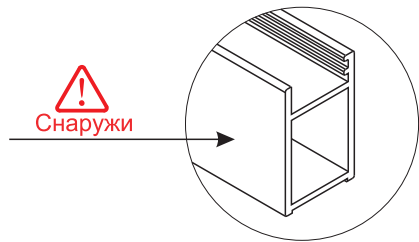

Это изделие тяжёлое и требуются два человека для установки.



⚠
Снаружи

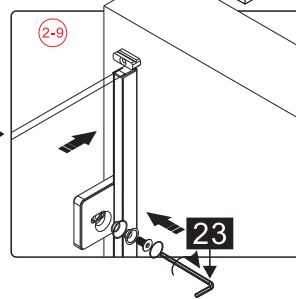
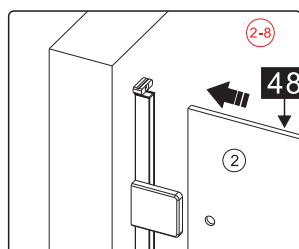
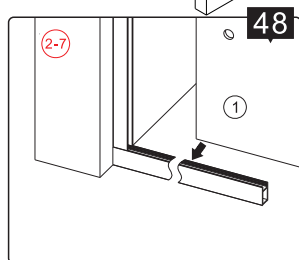
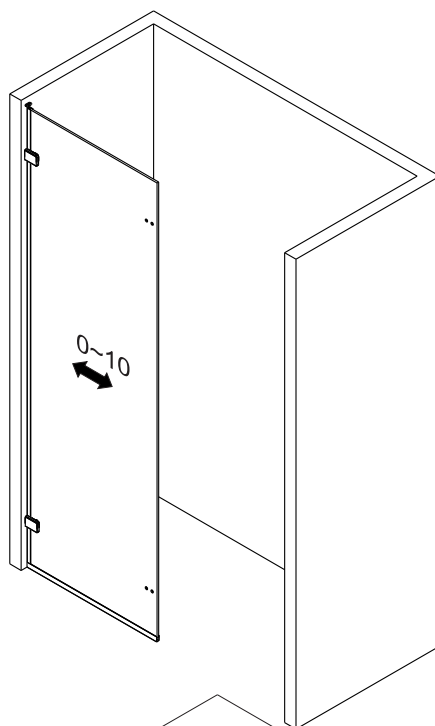
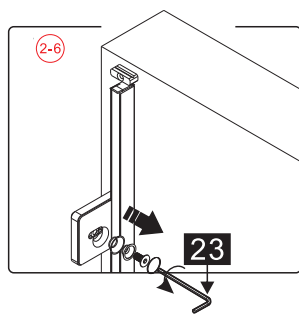
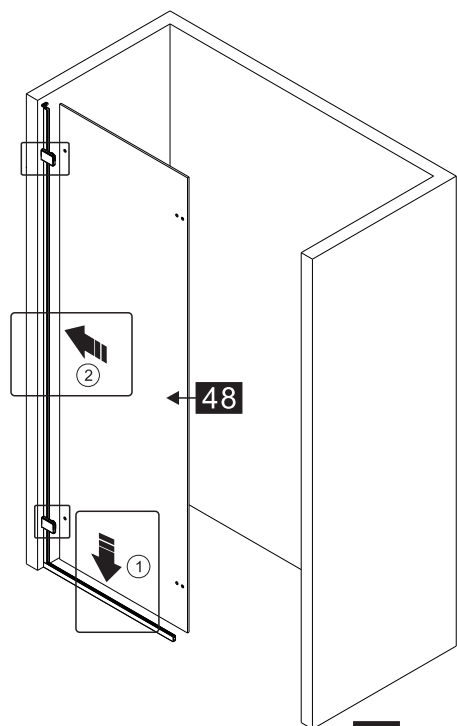
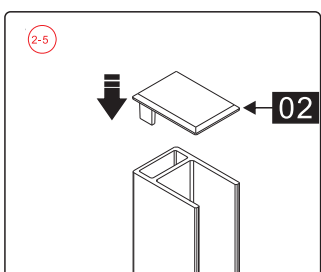
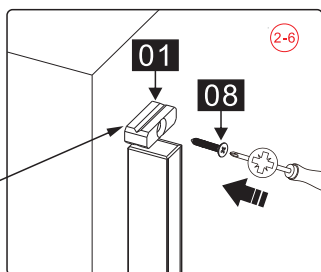
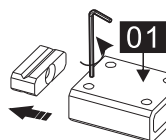
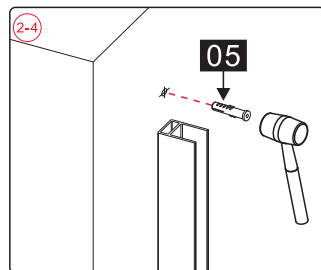
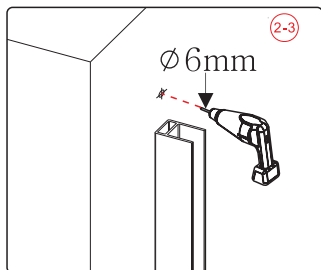
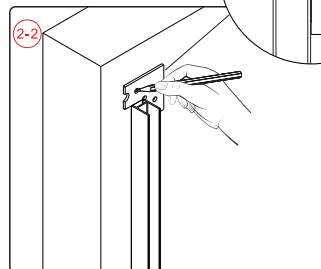
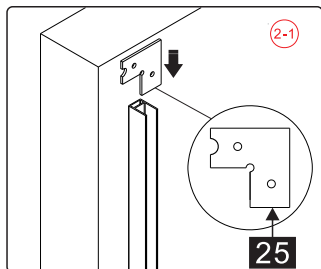
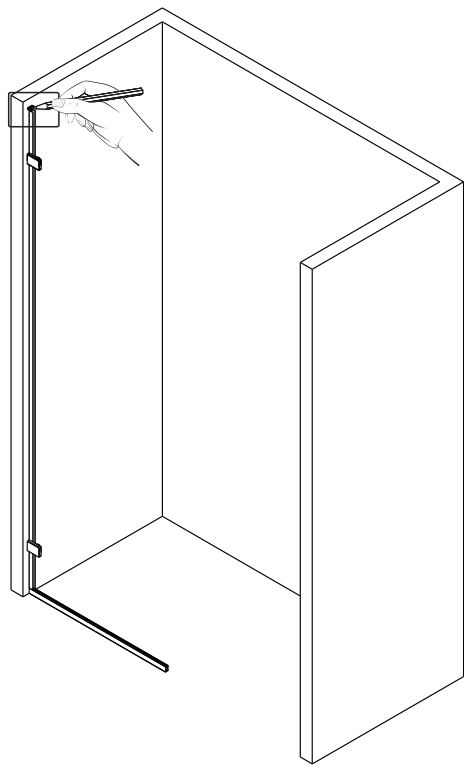
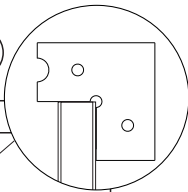

Это изделие тяжёлое и требуются два человека для установки.



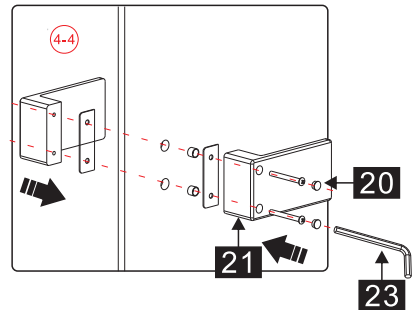
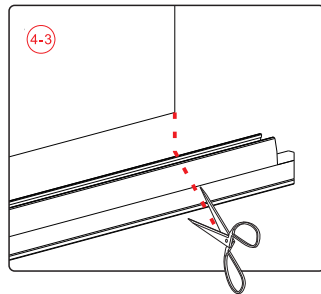
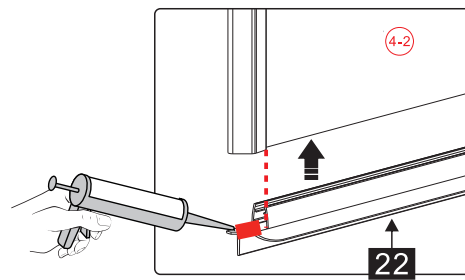
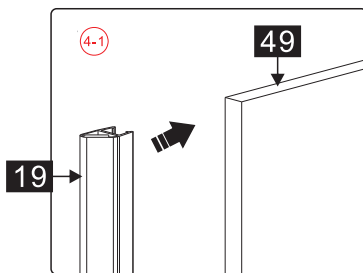
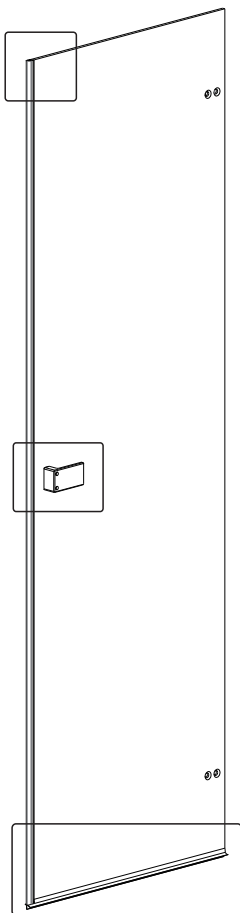
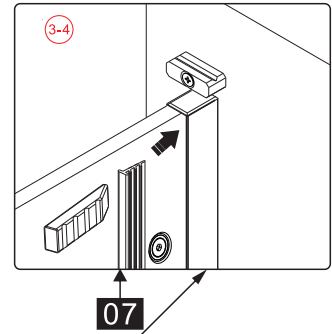
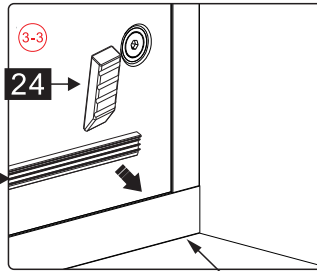
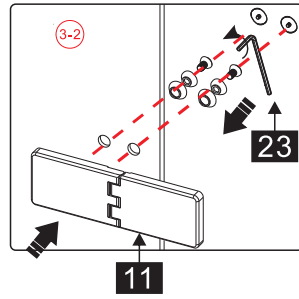
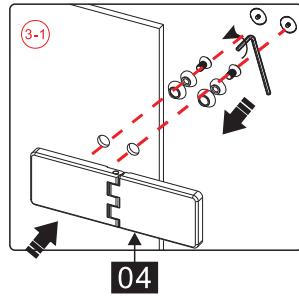
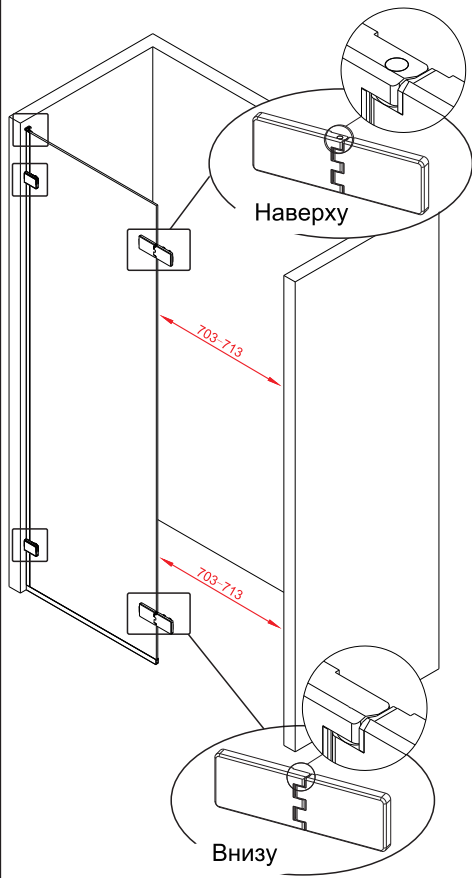

Это изделие тяжёлое и требуются два человека для установки.



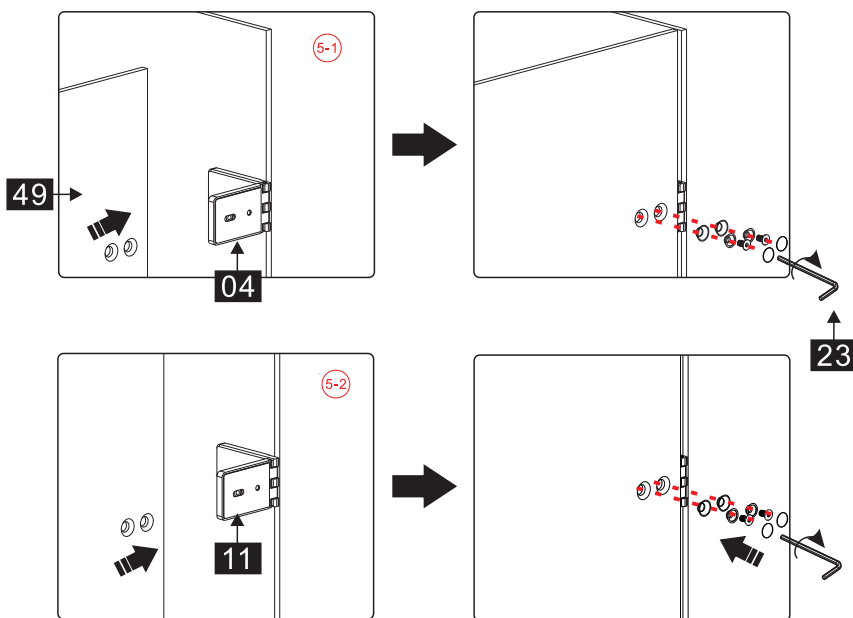
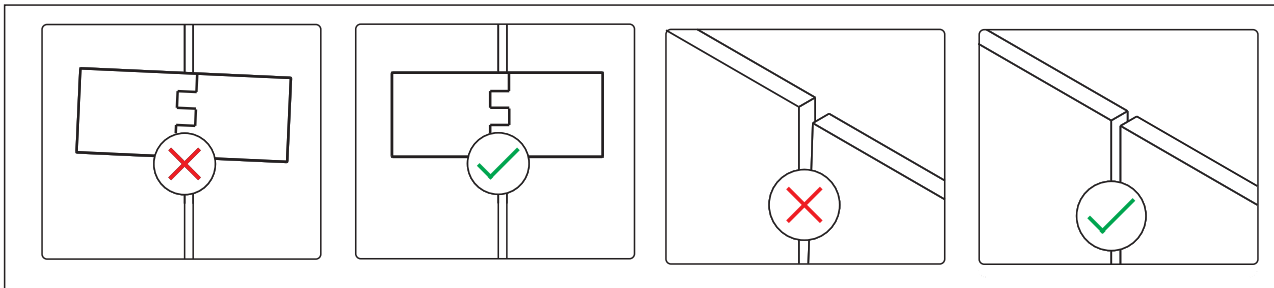
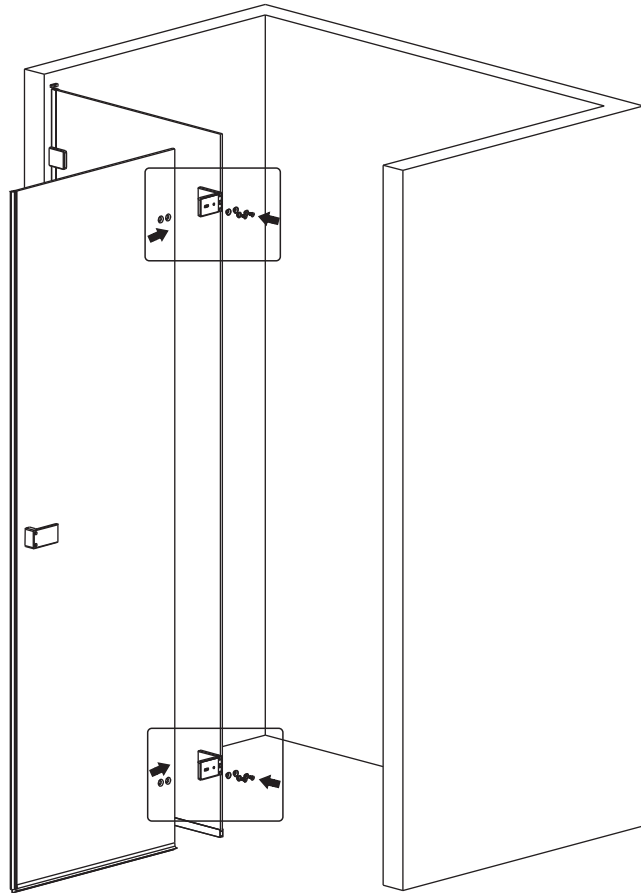

Это изделие тяжёлое и требуются два человека для установки.



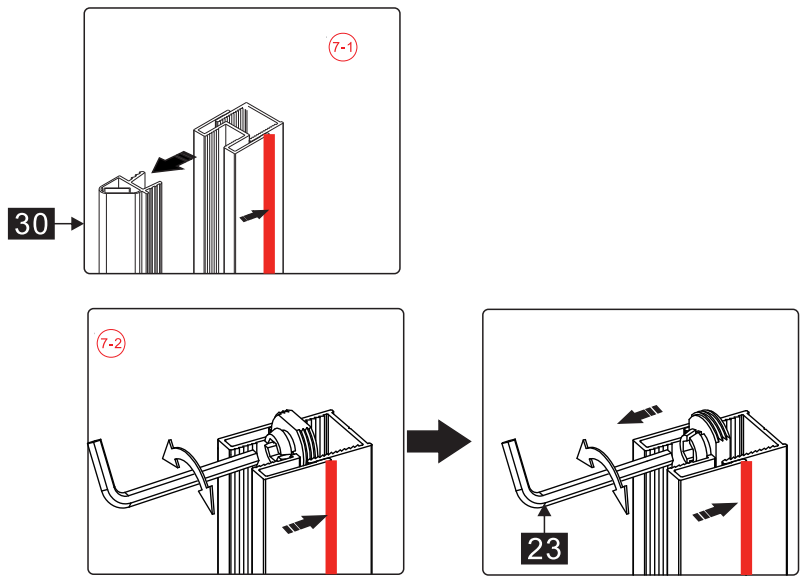
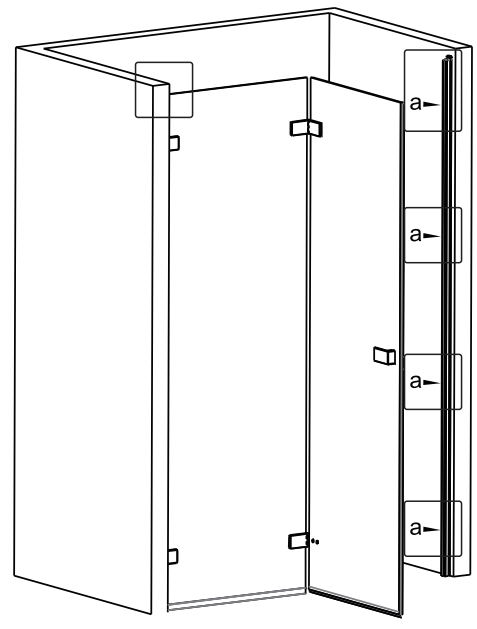
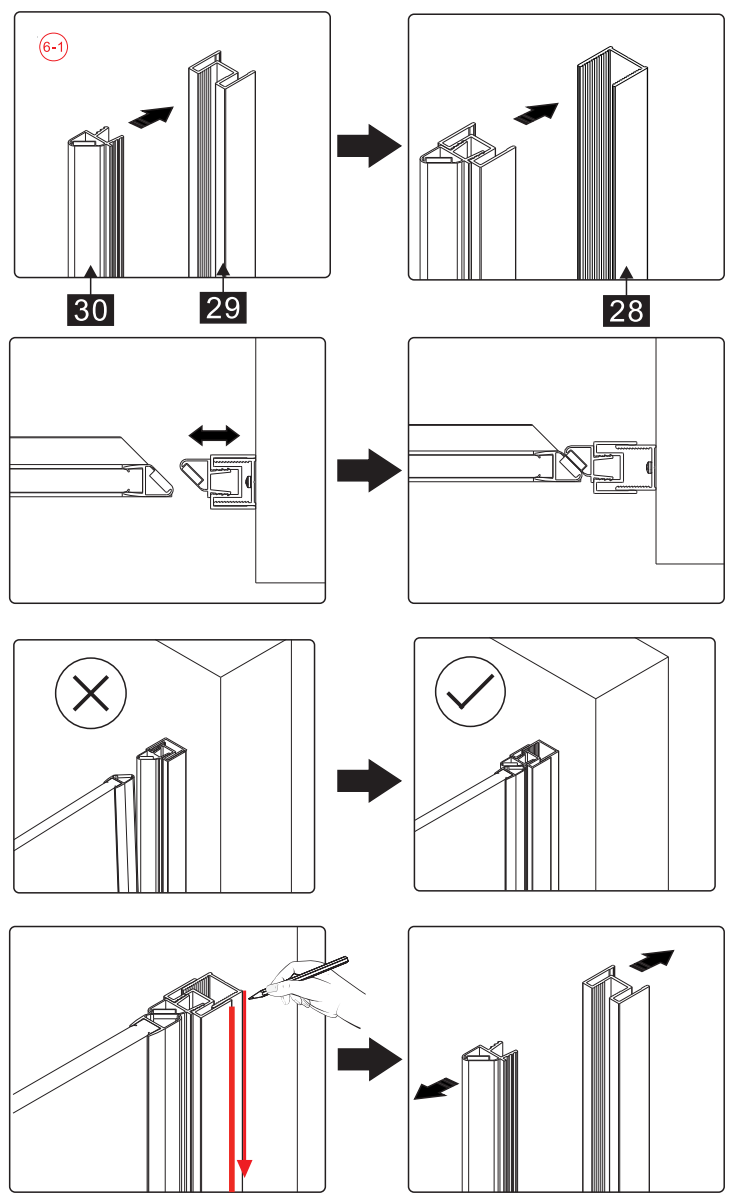
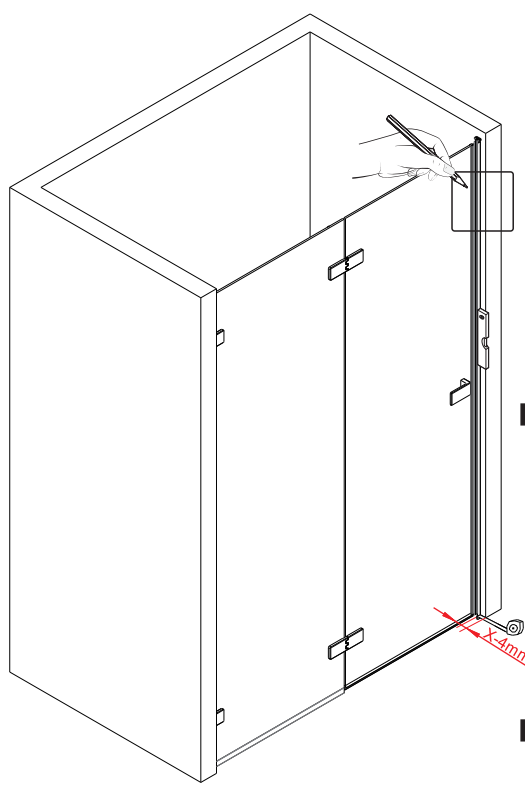

Это изделие тяжёлое и требуются два человека для установки.



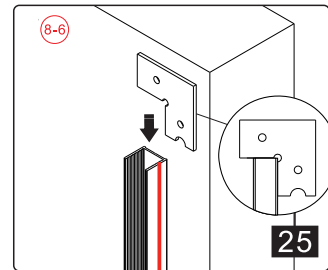
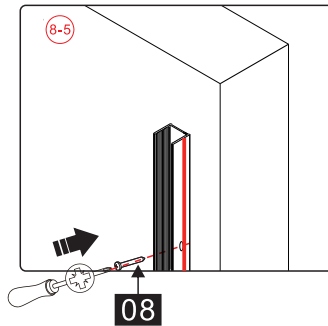
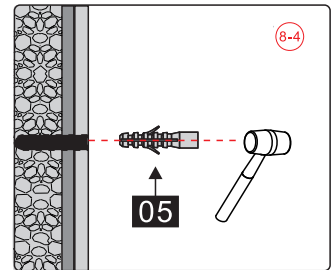
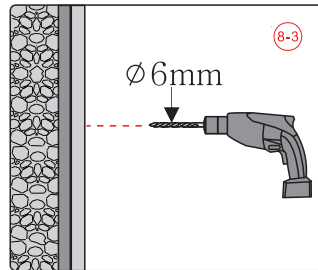
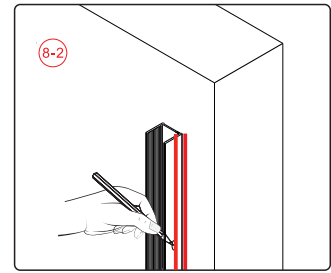
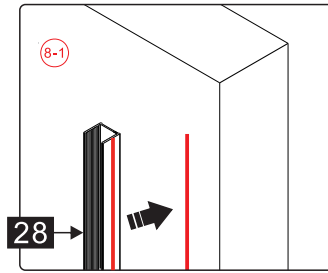
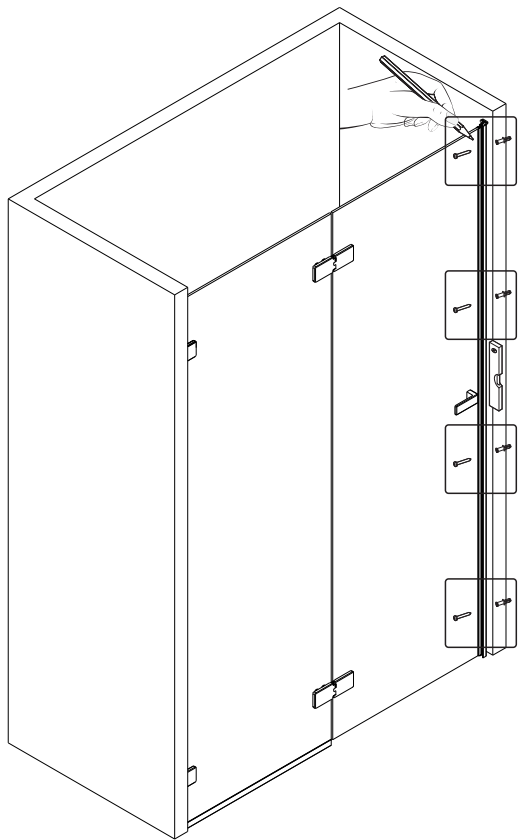

✓ ⚠
Снаружи

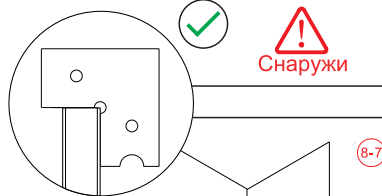

✓ ⚠
Снаружи

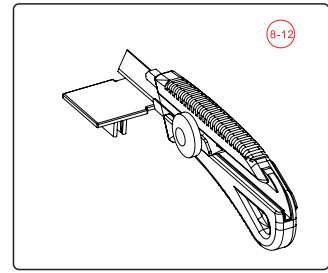
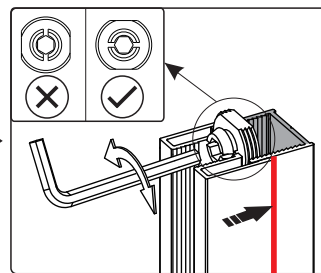
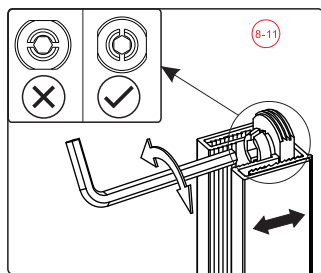
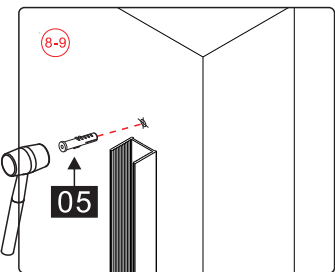
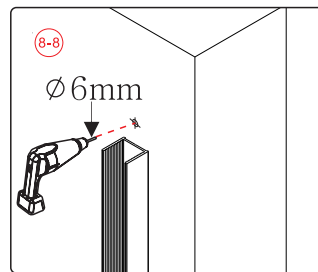
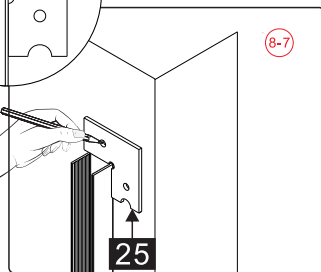

27

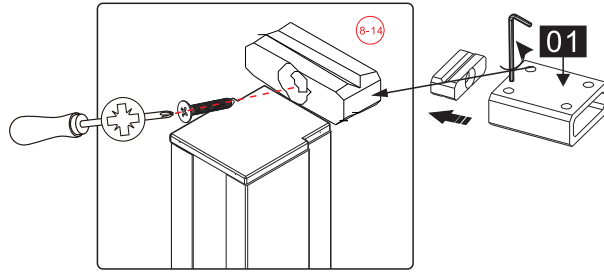
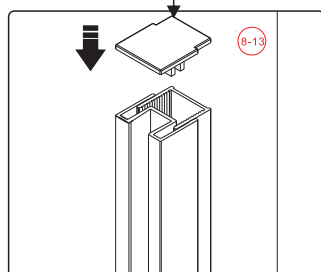

Это изделие тяжёлое и требуются два человека для установки.



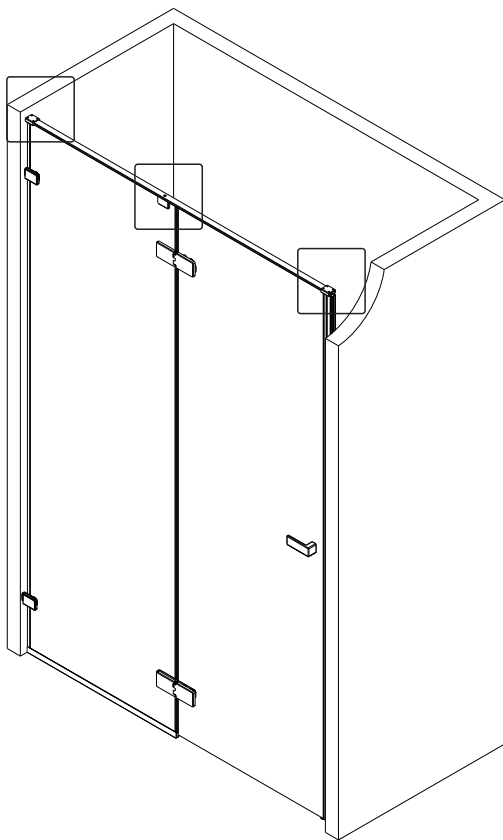
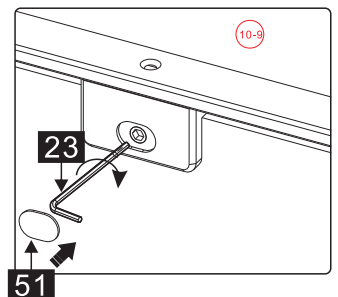
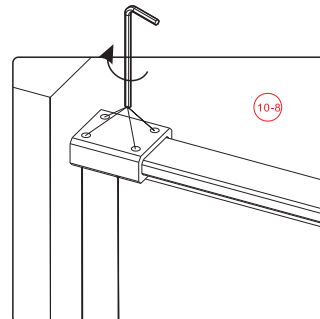
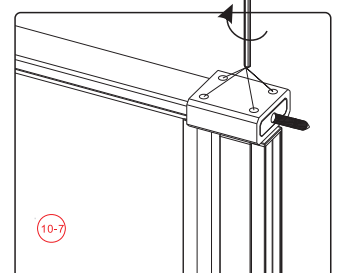
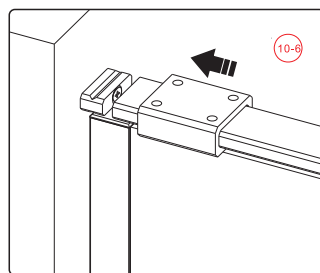
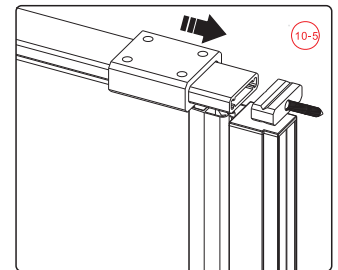
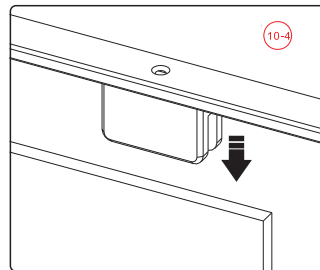
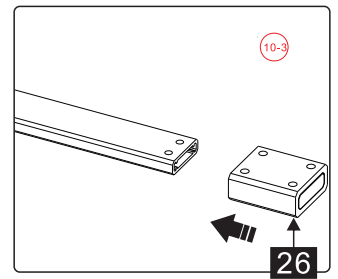
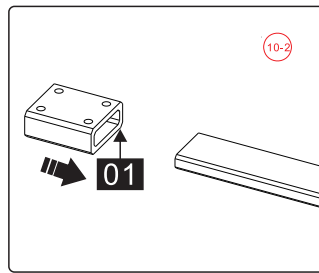
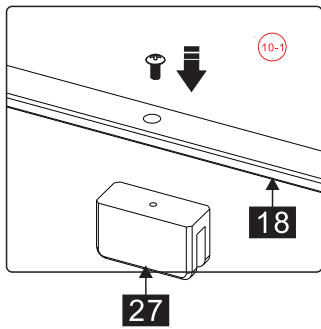
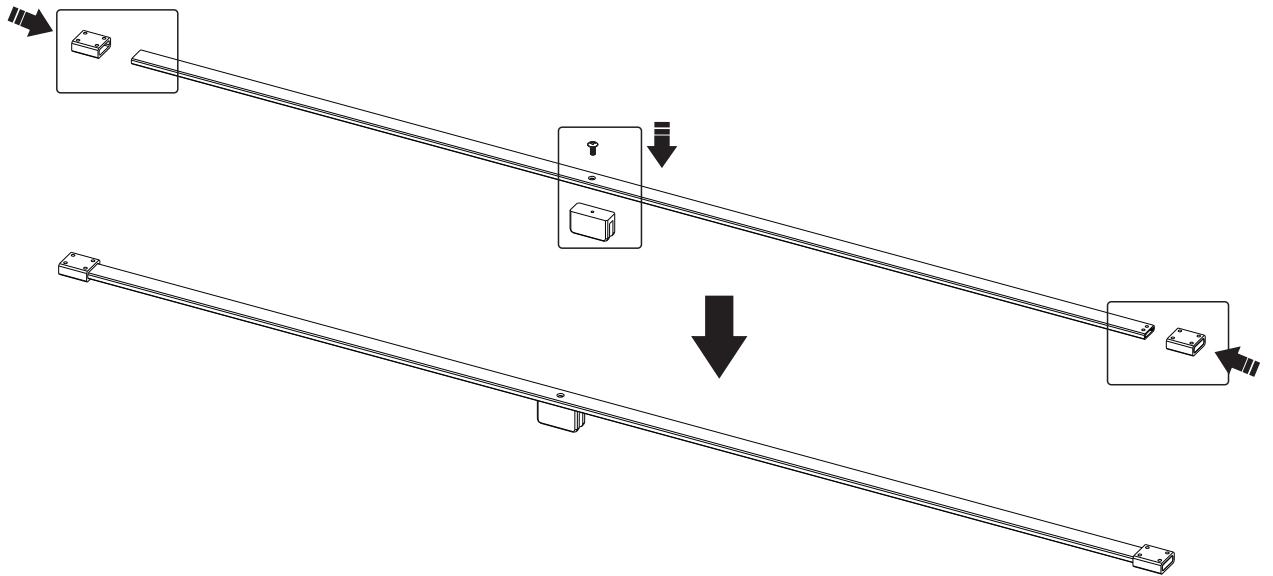

Это изделие тяжёлое и требуются два человека для установки.



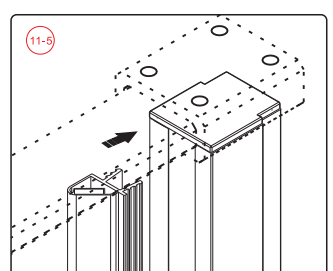
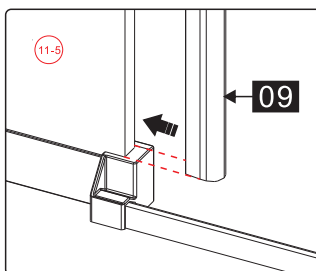
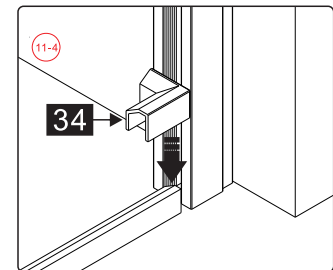
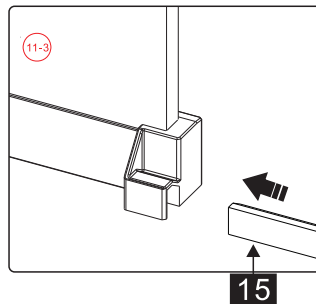
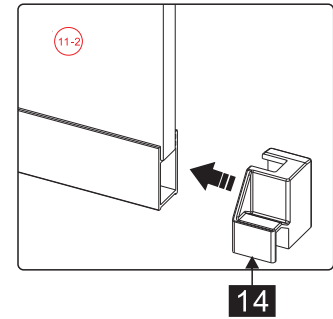
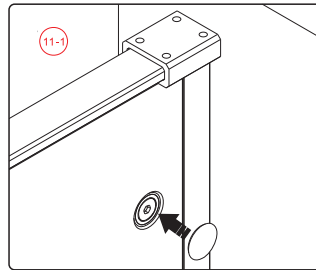
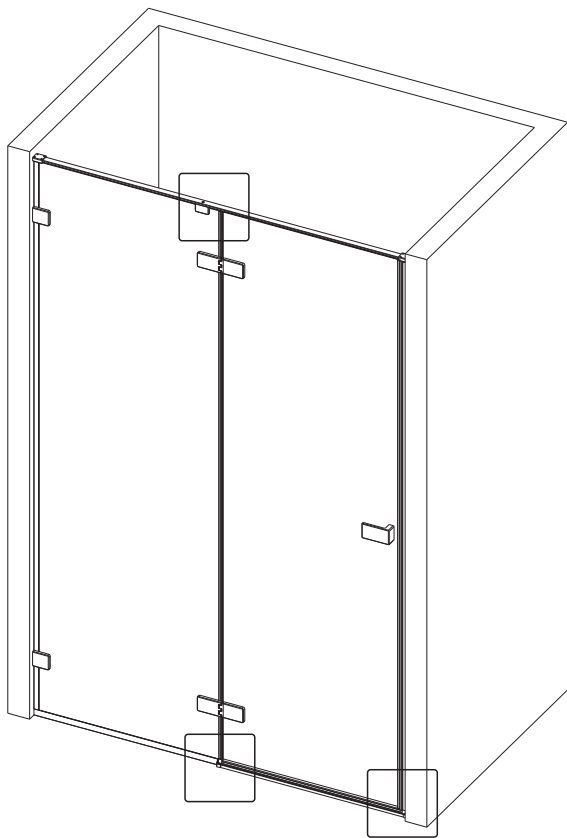
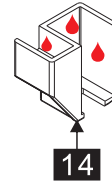
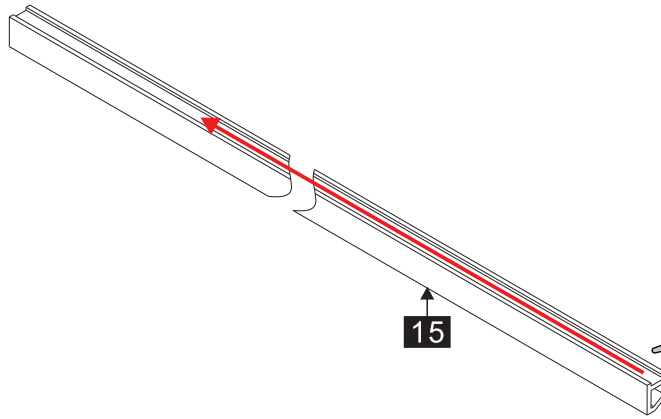
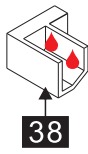

Это изделие тяжёлое и требуются два человека для установки.





13

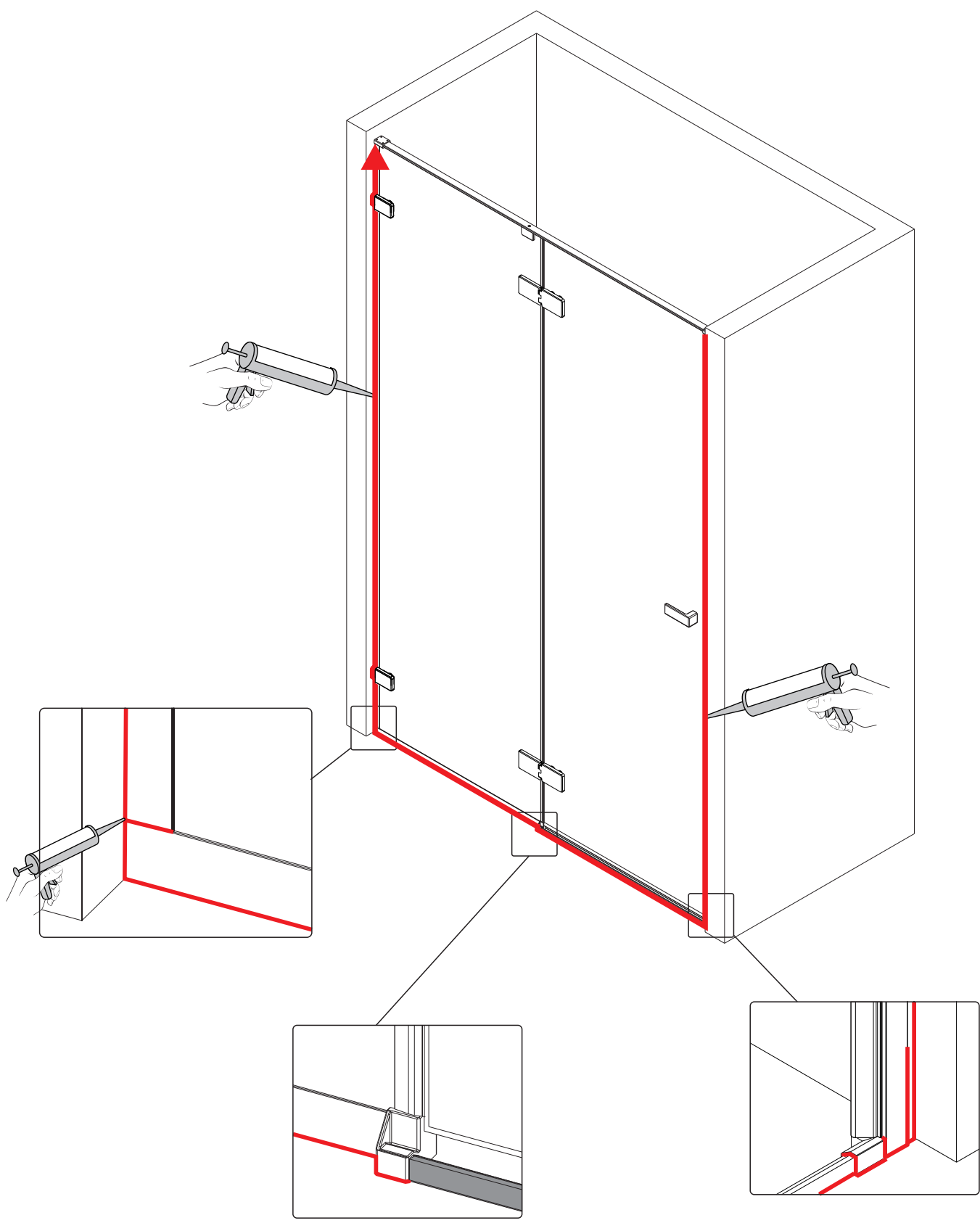







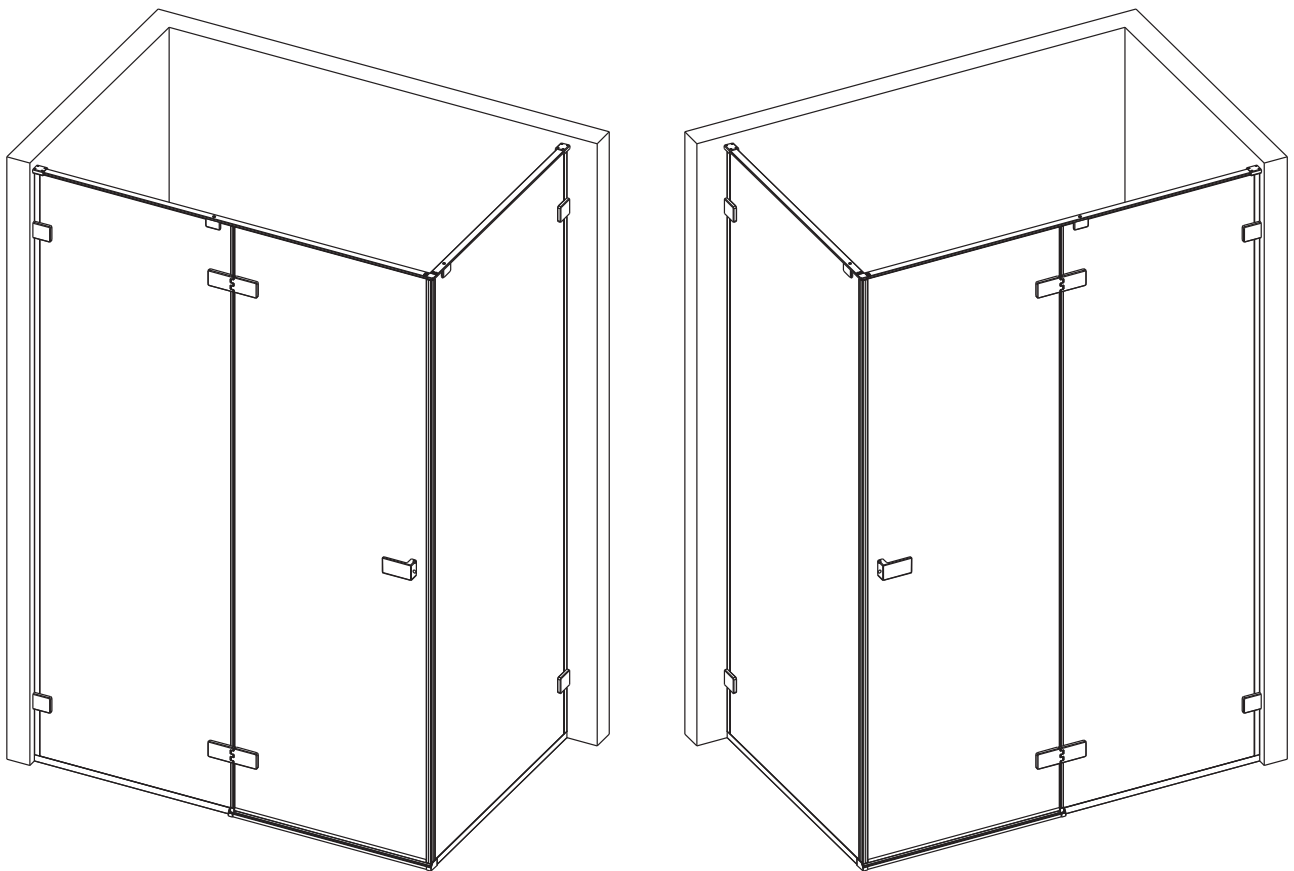

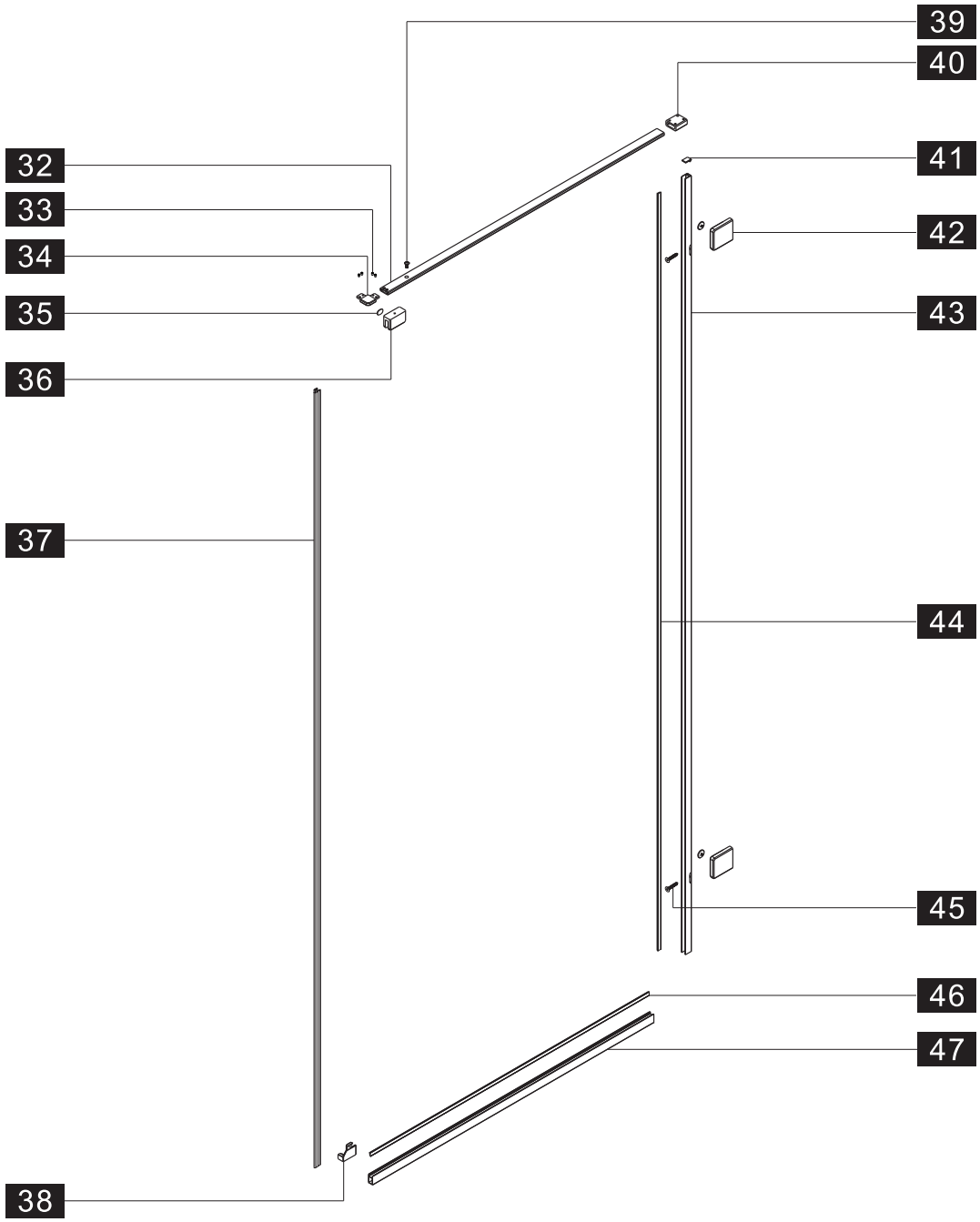









Это изделие тяжёлое и требуются два человека для установки.



BELLAGIO-A-1/АН-1





- | | | | | | | | | | | | | | |
|--|---|---|---|---|---|---|--|--|---|---|---|---|---|
|  32 x1 |  33 x4
M5*5 |  34 x1 |  35 x1 |  36 x1 |  37 x1 |  38 x1 |  39 x1
L R |  39 x2
M4*8 |  40 x1 |  41 x1 |  42 x2 |  43 x1 |  44 x1 |
|  8 x3
ST4.0x30 |  46 x1 |  47 x1 | | | | | | | | | | | |



Это изделие тяжёлое и требуются два человека для установки.





15



Это изделие тяжёлое и требуются два человека для установки.



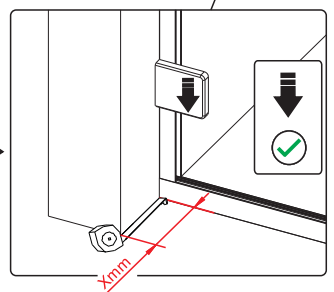
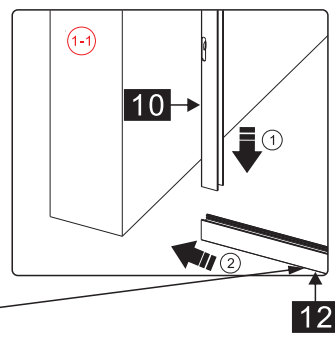
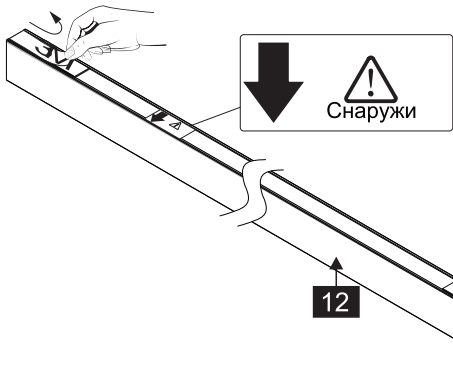
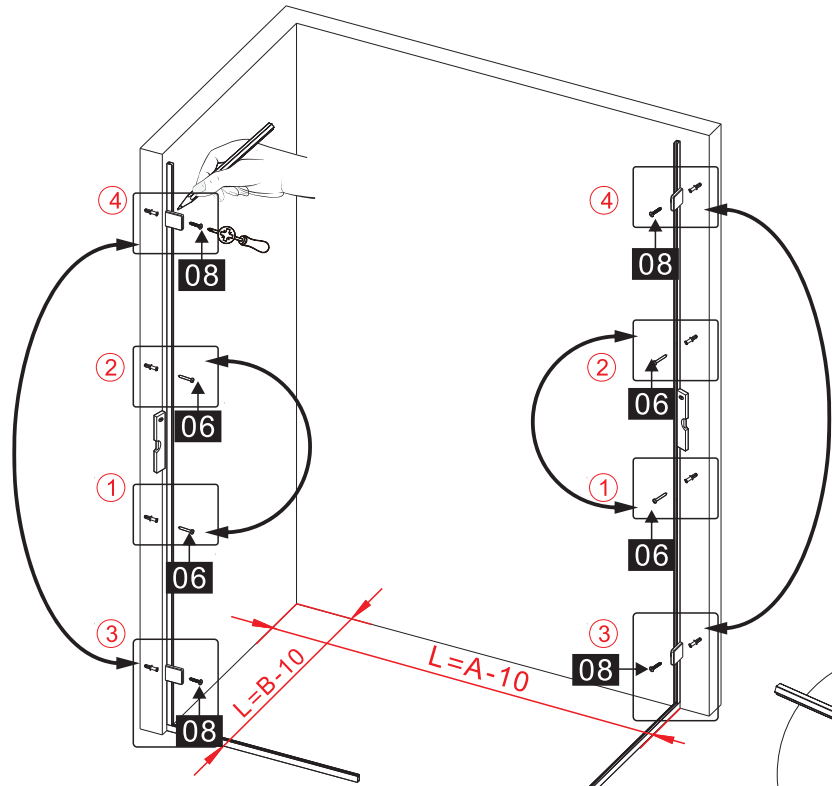

Вставьте петлю в нижнюю часть прорези и зафиксируйте положение.

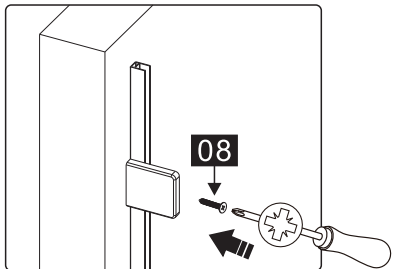
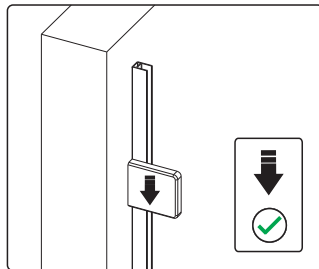
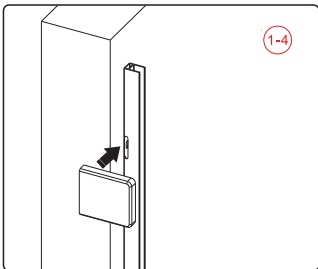
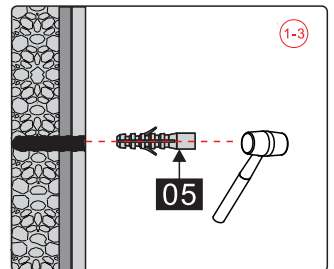
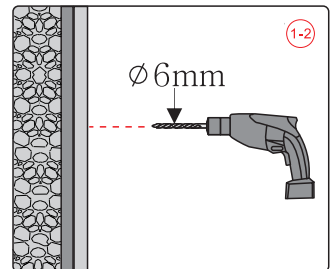
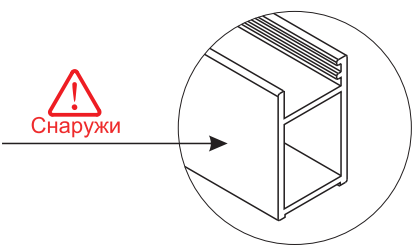

Это изделие тяжёлое и требуются два человека для установки.



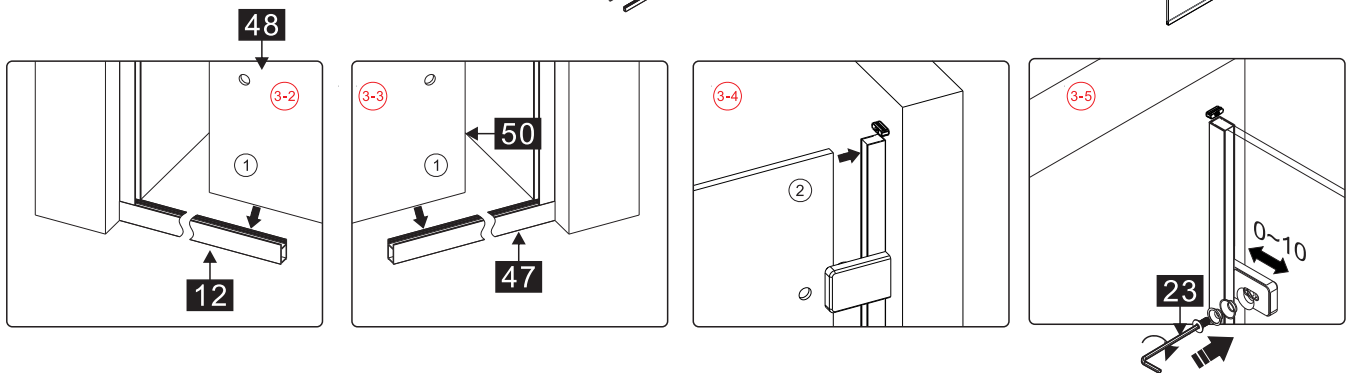
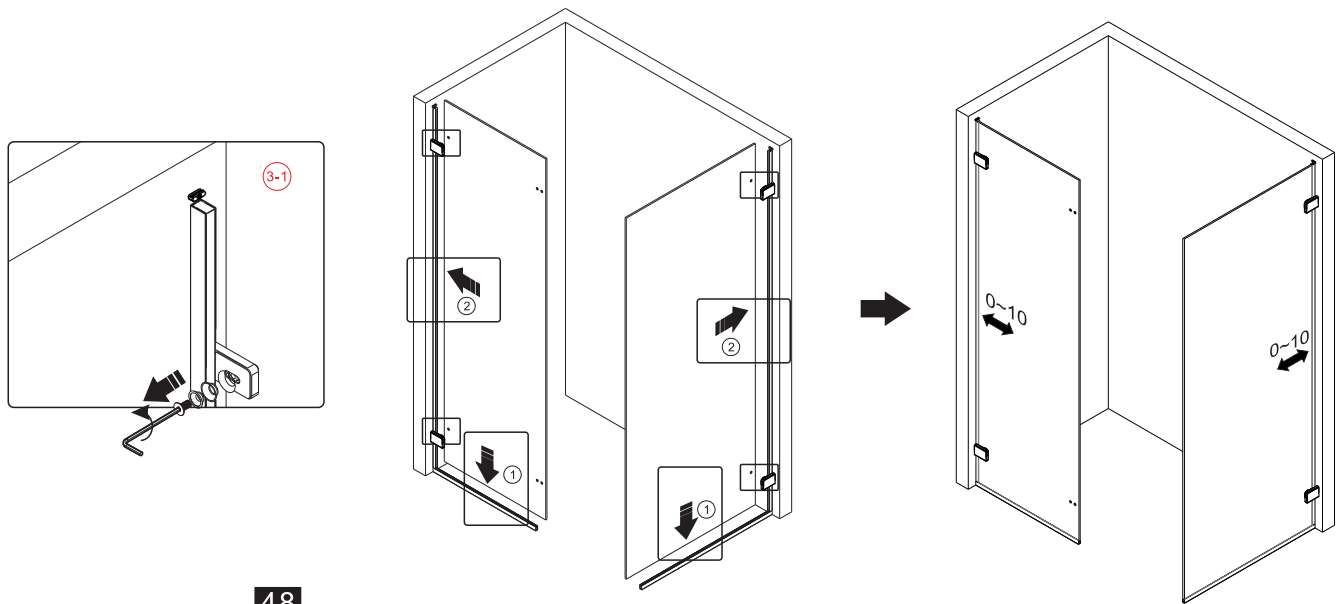
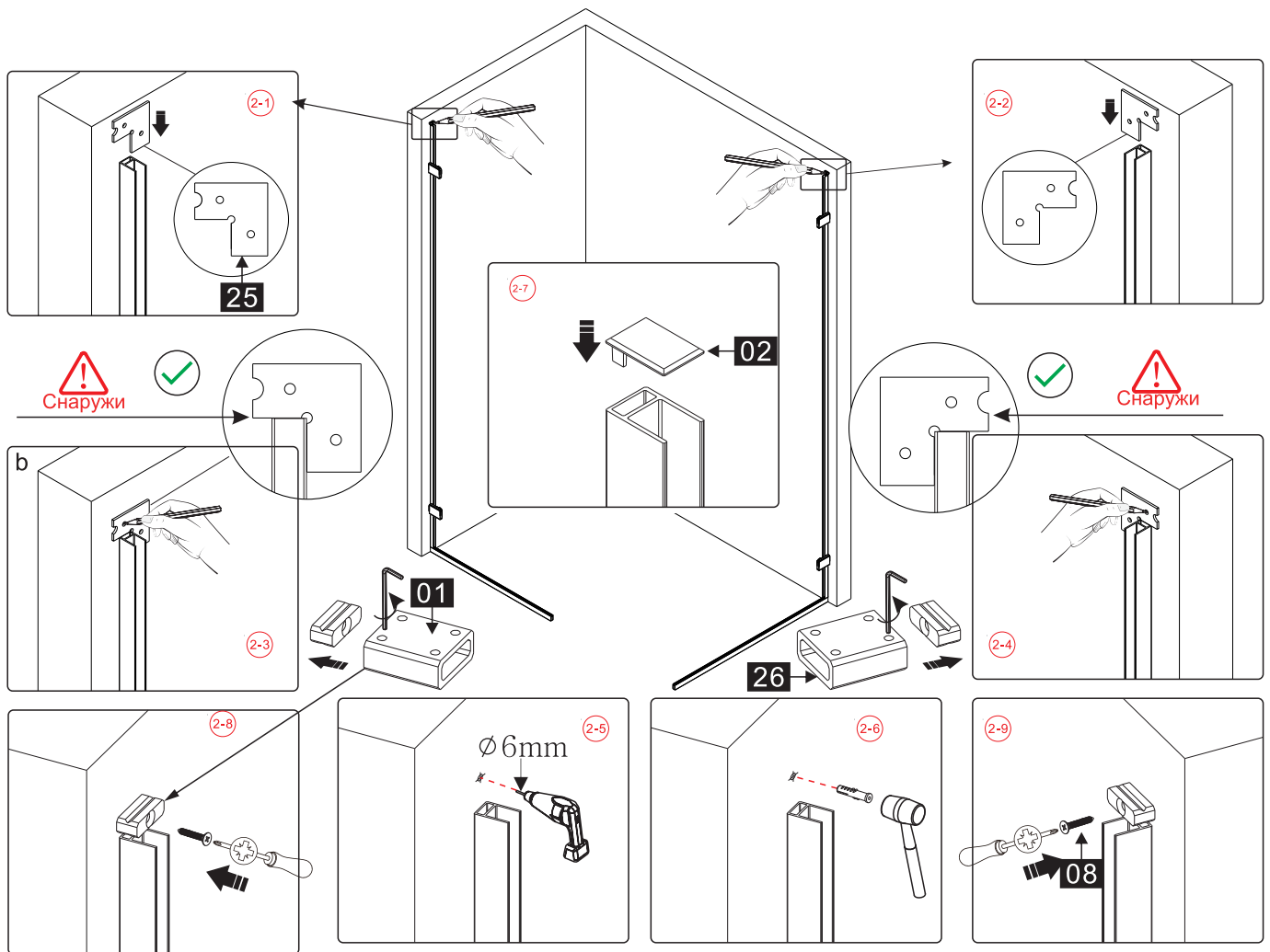

Это изделие тяжёлое и требуются два человека для установки.



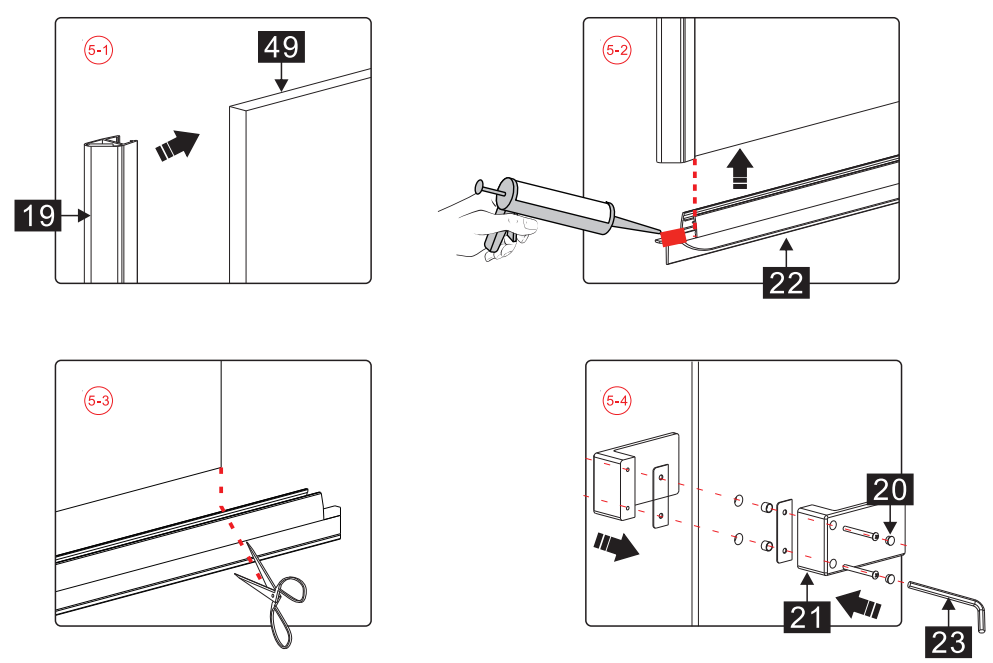
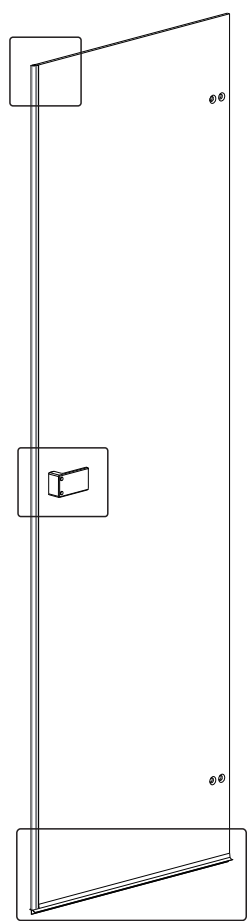
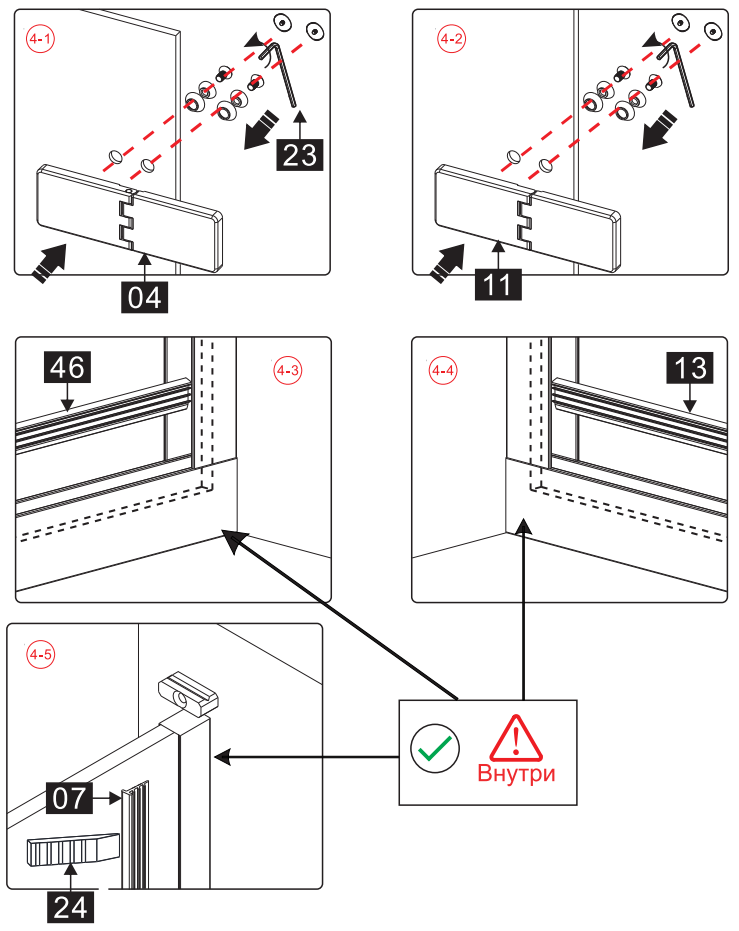
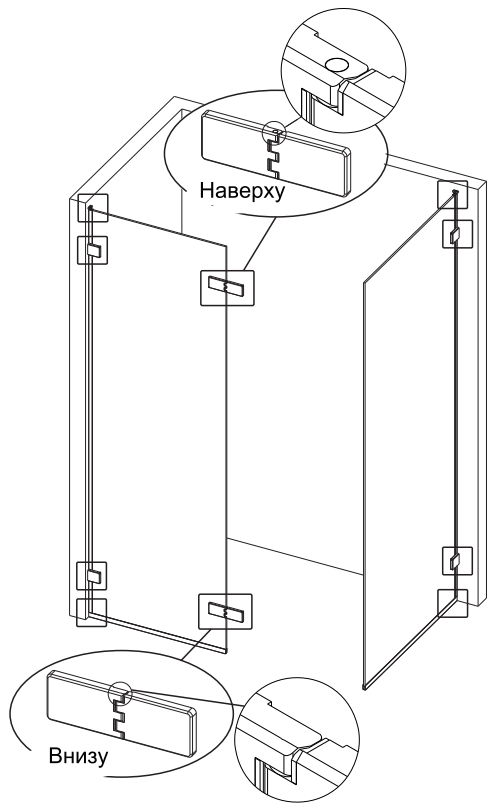

Это изделие тяжёлое и требуются два человека для установки.



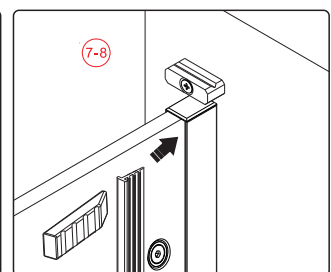
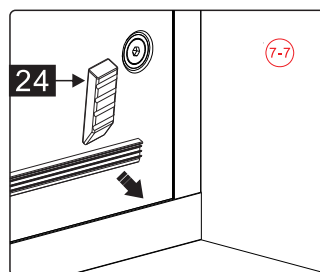
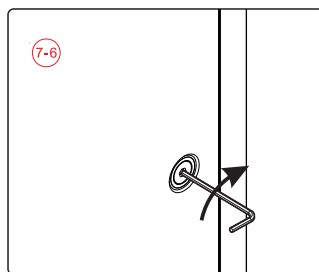
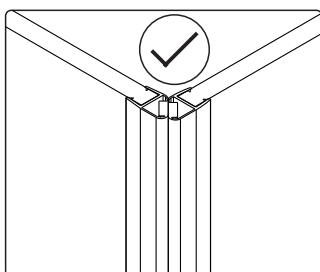
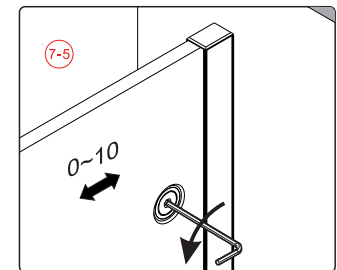
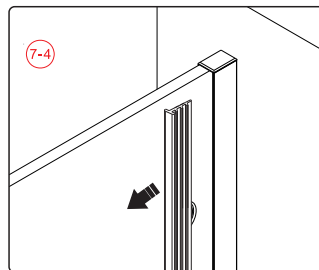
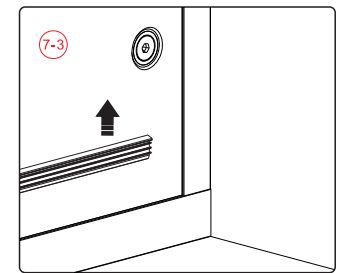
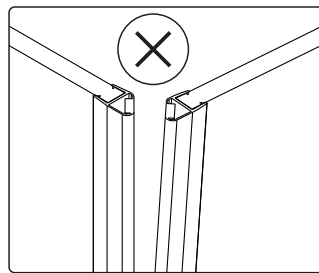
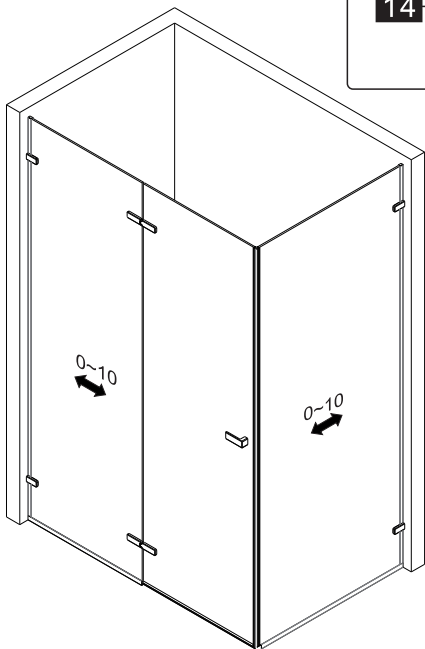
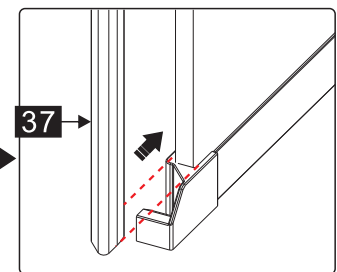
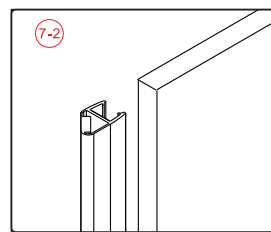
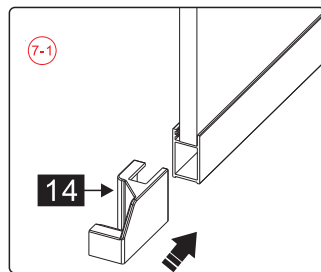
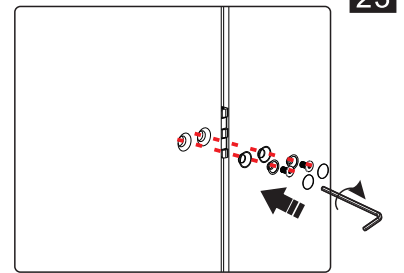
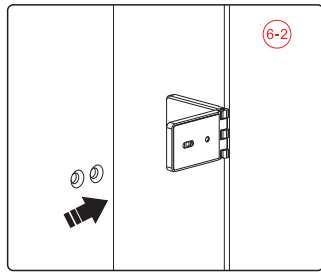
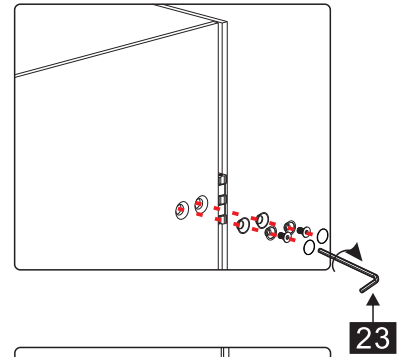
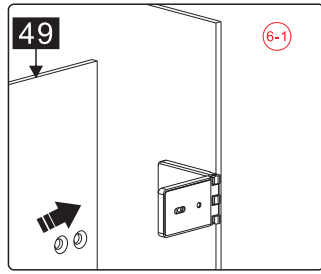
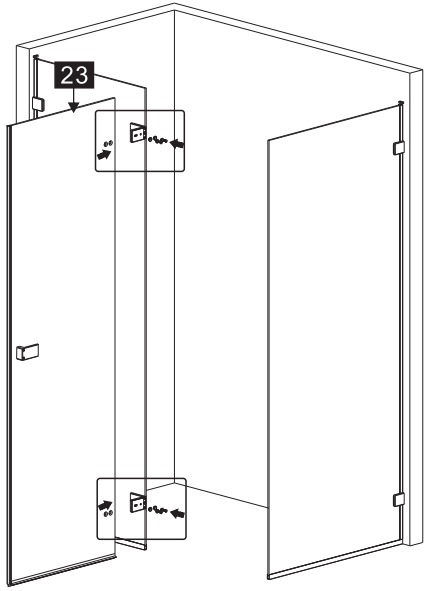
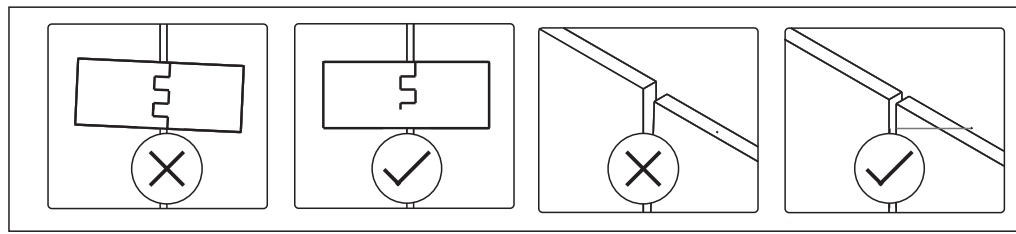

Это изделие тяжёлое и требуются два человека для установки.



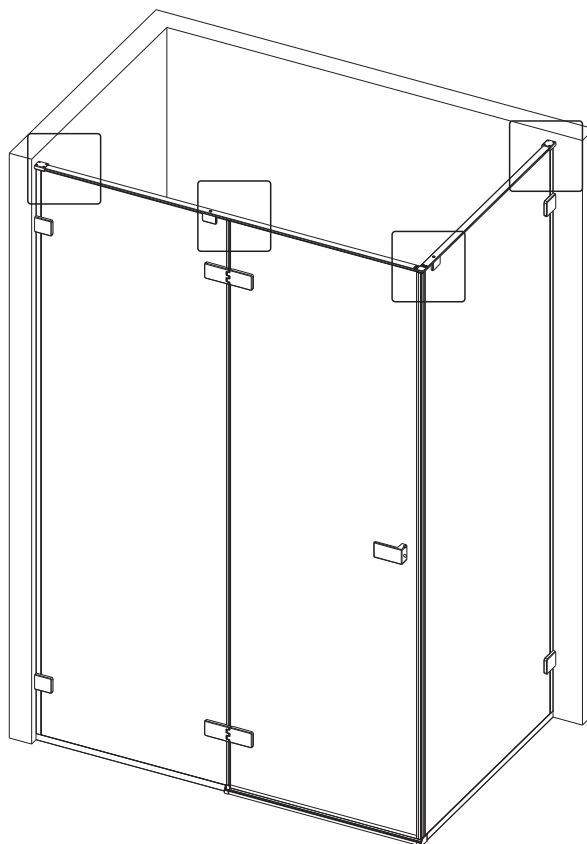
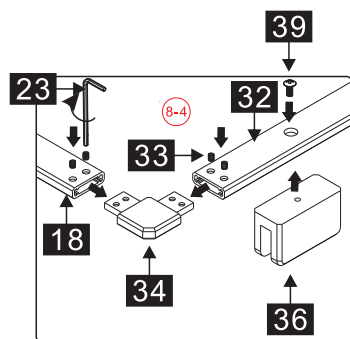
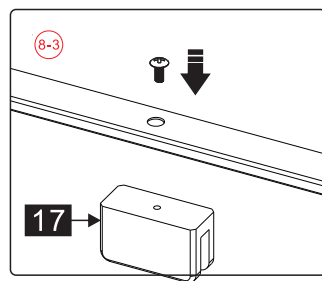
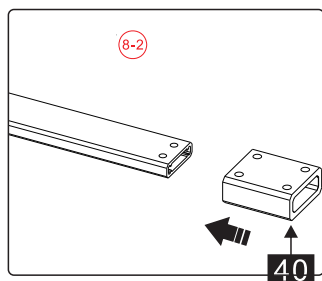
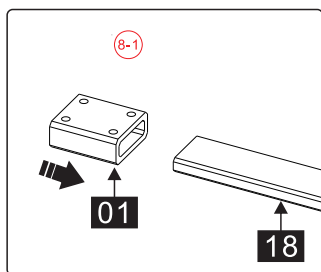
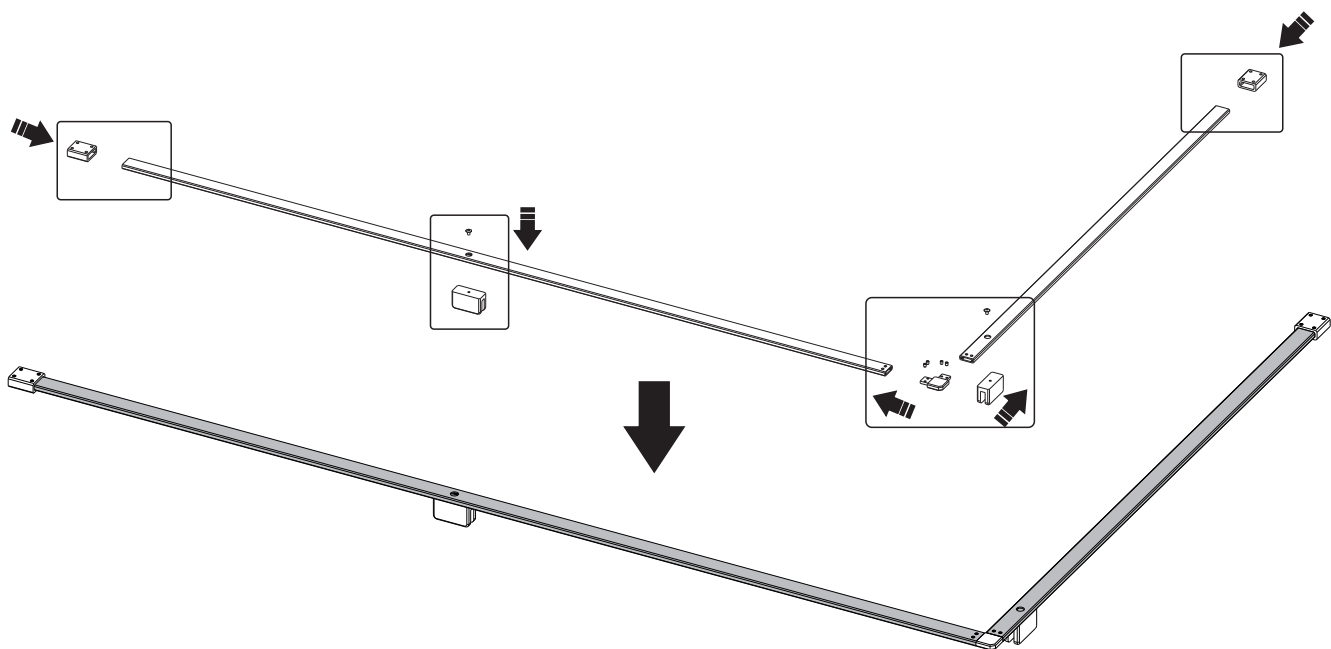

Это изделие тяжёлое и требуются два человека для установки.



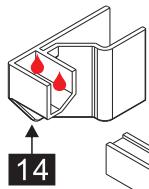
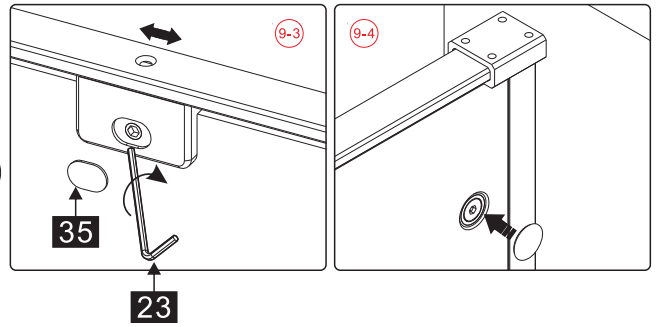
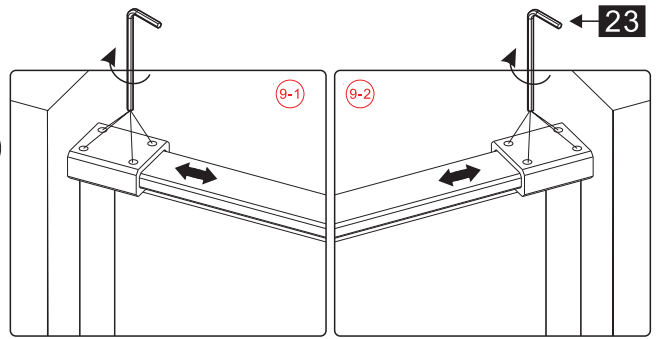
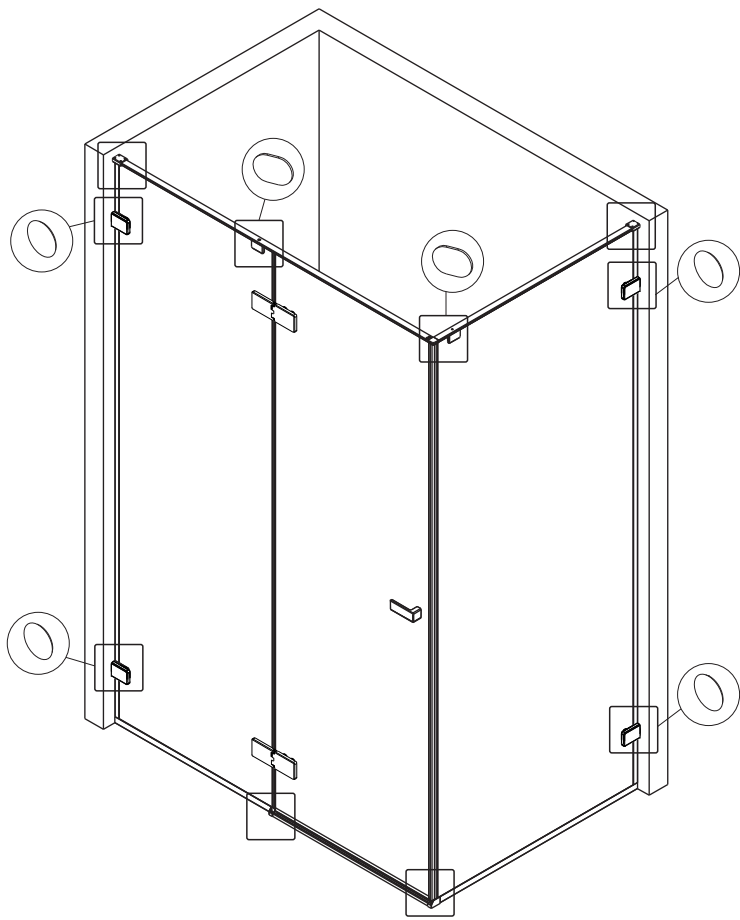

14

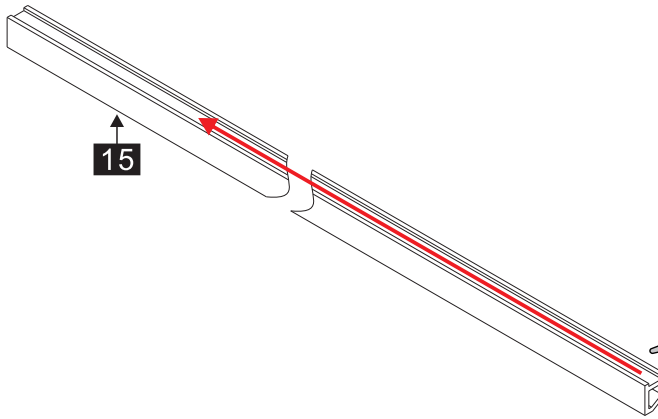

15

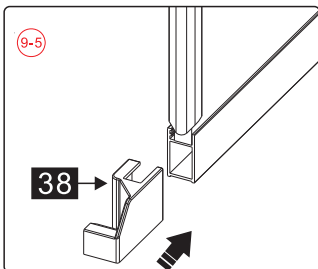
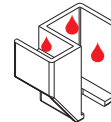

9-5

38

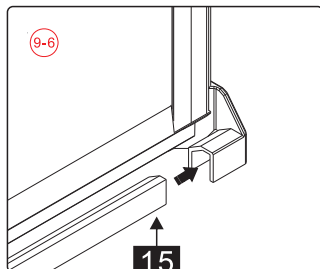

9-6

15

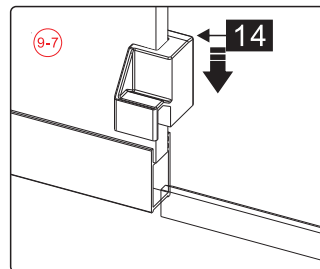

9-7

14

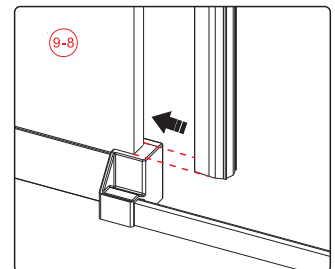

9-8



Это изделие тяжёлое и требуются два человека для установки.



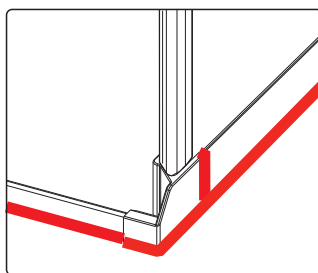
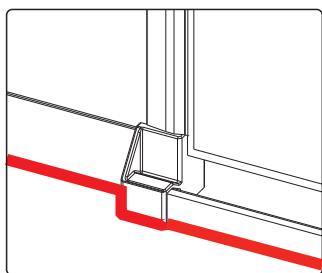
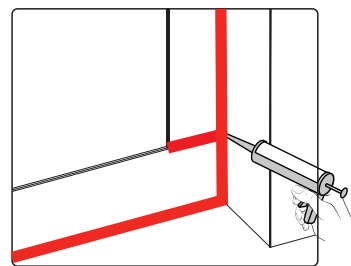
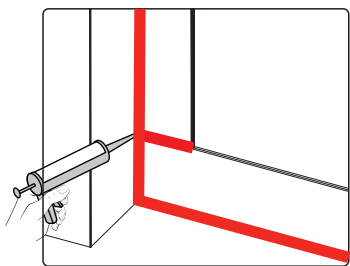
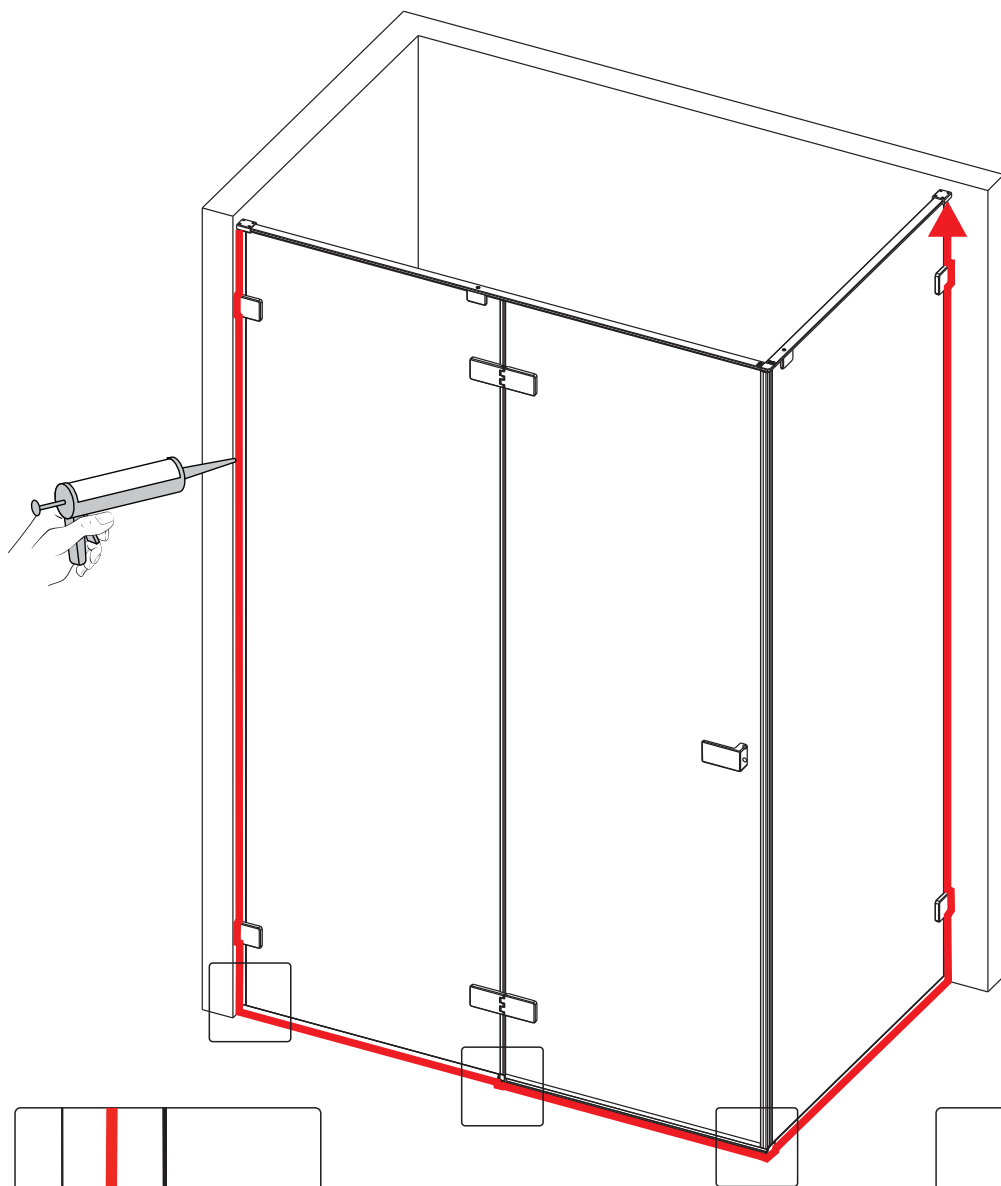

22



Это изделие тяжёлое и требуются два человека для установки.



Достоверную информацию уточняйте на santehnica.ru.