

Not included / Non incluso / Non Inclus / Nie zawarty / No incluido / Nao incluido

1

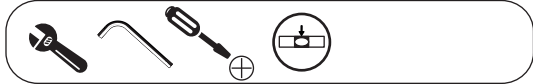

A1

A2

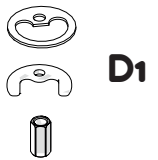

D1



D2

DISPONIBILE SOLO PER ALCUNE SERIE
AVAILABLE ONLY FOR SOME SERIES

ANELLO DI GUIDA
GUIDE RING

118/1

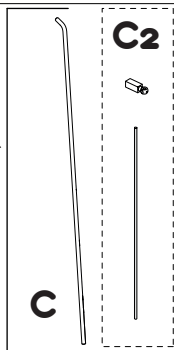

C2

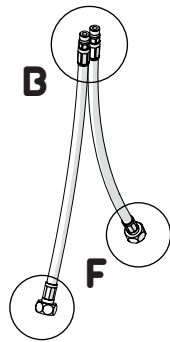

B

F

118/1

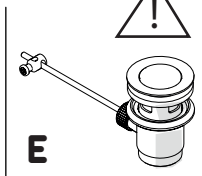

E

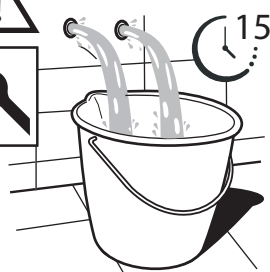
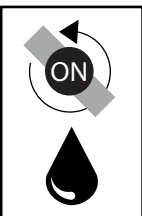

15s

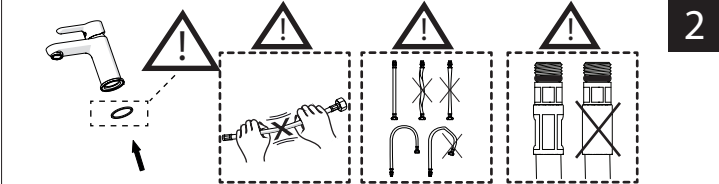
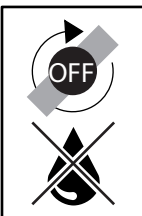

2

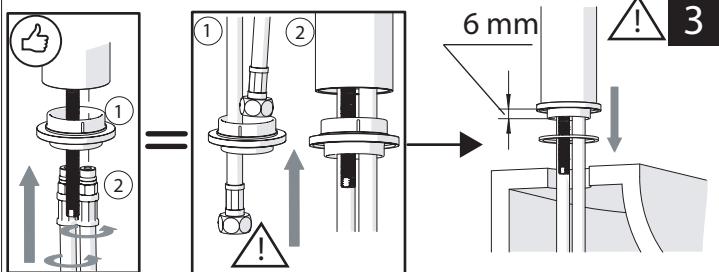
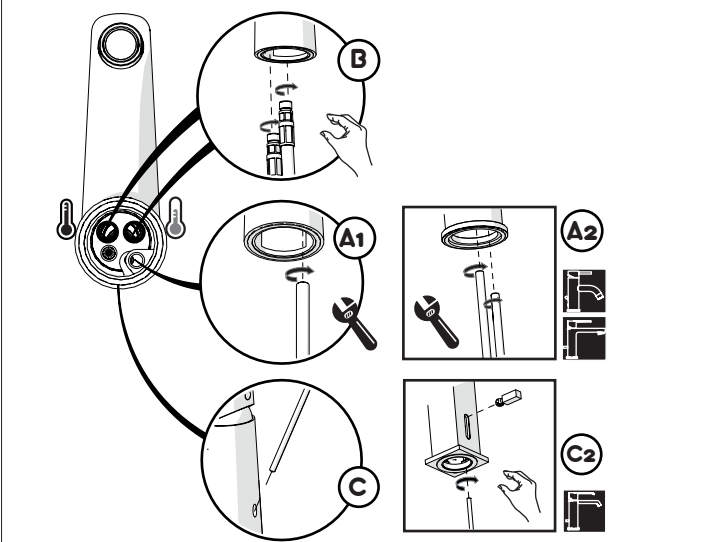

3

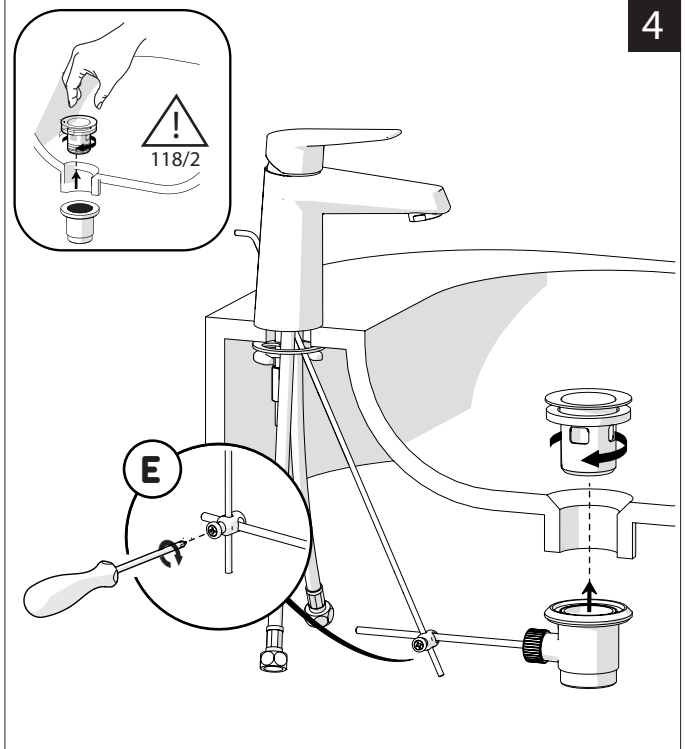
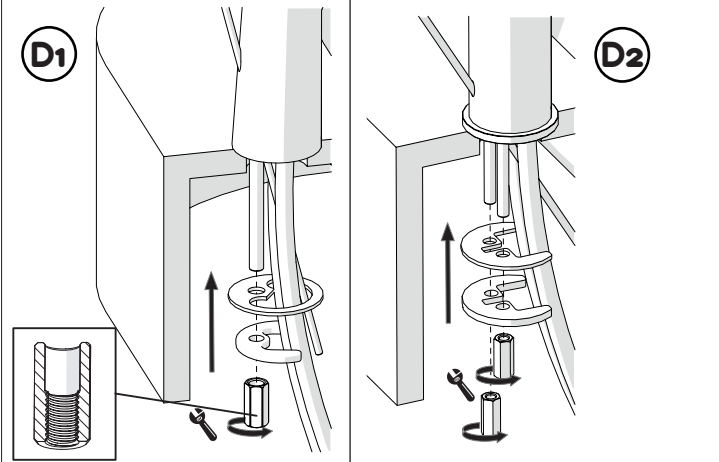

4

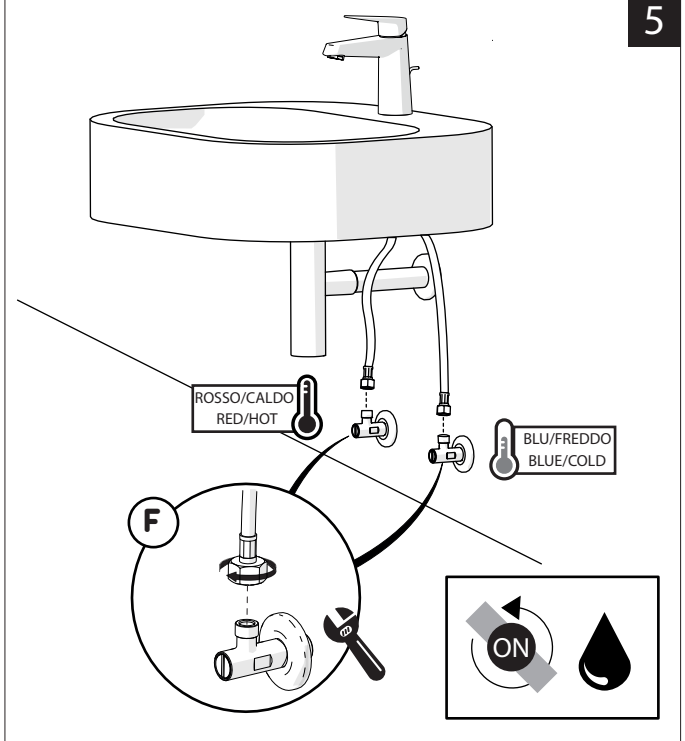

5



Dispositivo limitatore "dinamico" della portata d'acqua "50%"

"Dinamic" flow rate restrictor "50%"



VARIE POSSIBILITA' PER SMONTARE L'AERATORE
SEVERAL OPTIOS FOR REMOVING AERATOR



ESEMPI DISEGNO TECNICO
EXAMPLES OF TECHNICAL DRAWING

6

CLOSE ON 50% ON 100%

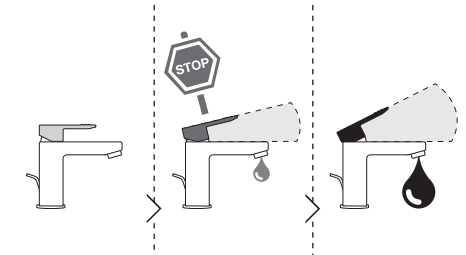

Posizione di chiusura
Closed position

Posizione di risparmio acqua "50% portata"
Position of water saving "50% capacity"

Posizione di apertura totale 100% portata
100% Fully open flow

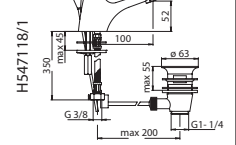
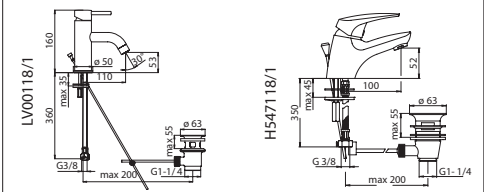
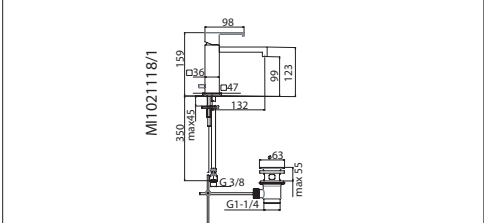
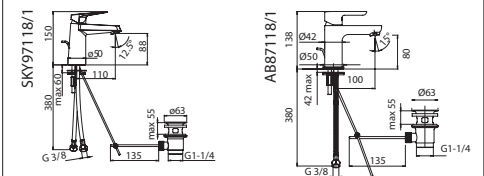
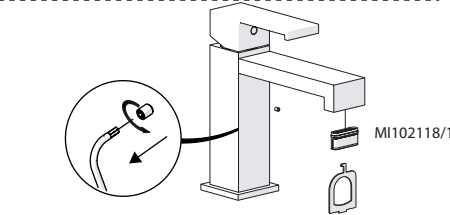
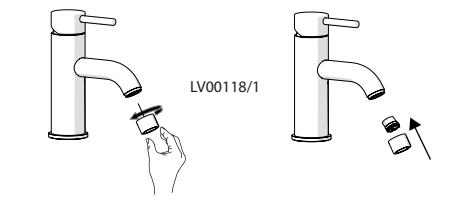
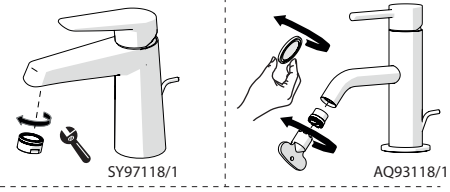
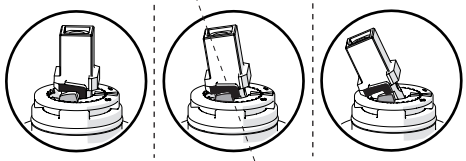

7

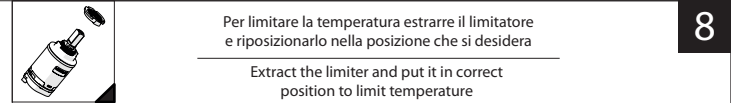
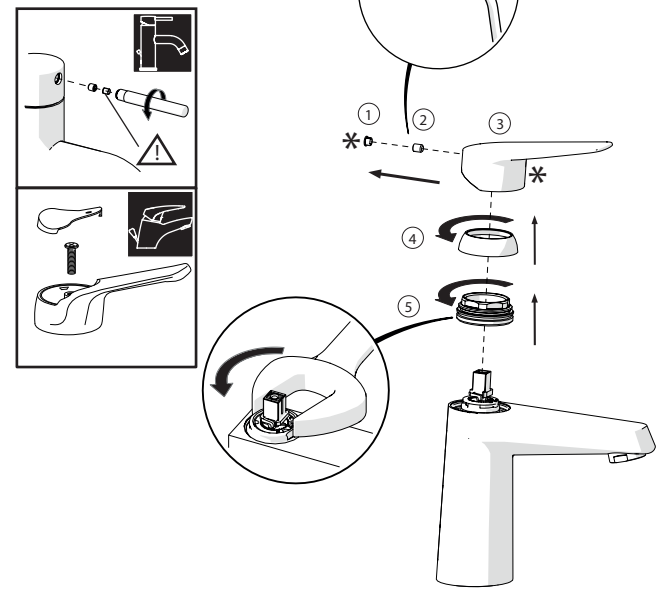

8

Per limitare la temperatura estrarre il limitatore e riposizionarlo nella posizione che si desidera

Extract the limiter and put it in correct position to limit temperature

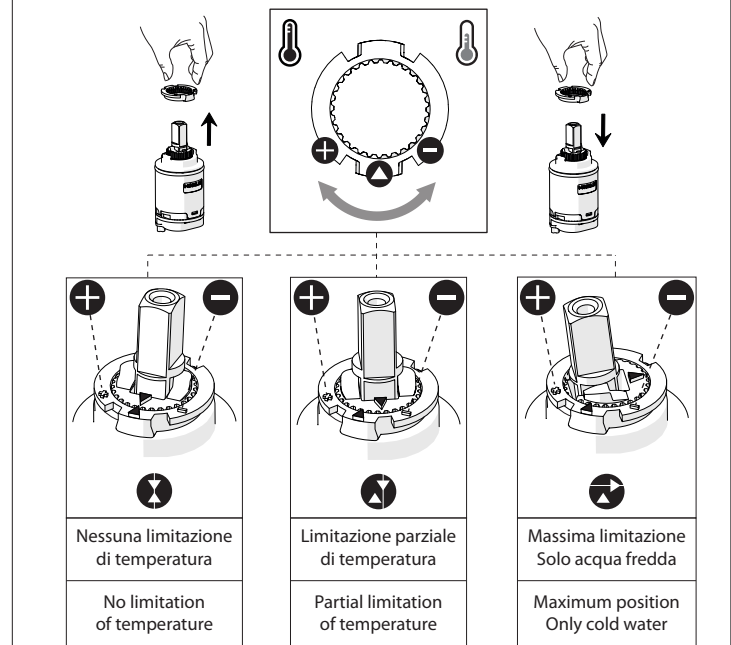

NOBILIS

118

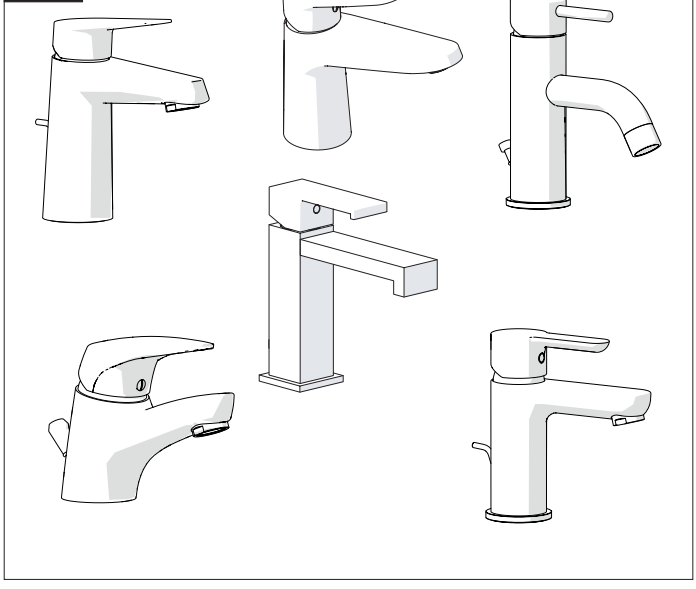

www.nobili.it

PRIMA DI INIZIARE / BEFORE STARTING

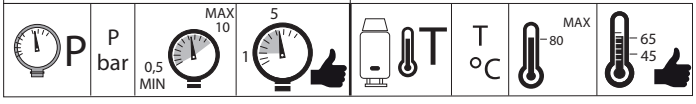

PULIZIA / CLEANING



IISTR00118#---STD



REV4.07/2020

Достоверную информацию уточняйте на santehnica.ru.