

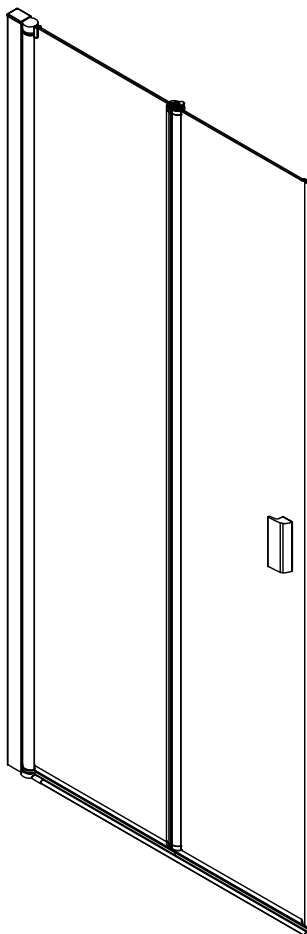

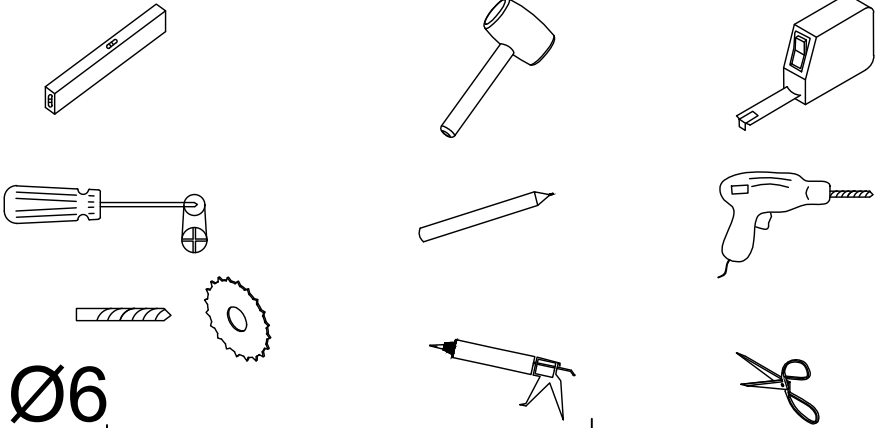

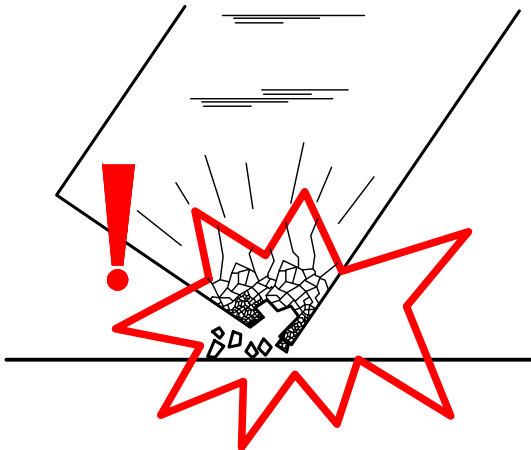

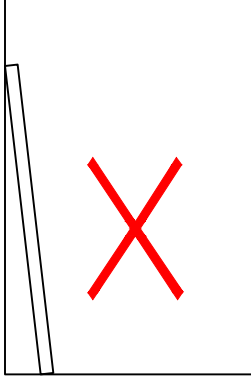







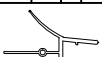

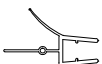
# RGW 2882





Ø6



Номер	Изображение	Параметры	Кол-во	Пометки
1			3 ШТ	
2			1 ШТ	
3			1 ШТ	
4			1 ШТ	
5			1 ШТ	
6			1 ШТ	
7			1 ШТ	
8			1 ШТ	
9			1 ШТ	
10		ST 3. 9x35	3 ШТ	
11		ST 3. 5x9.5	3 ШТ	
12			2 ШТ	
13			2 ШТ	
14		M 2.5	1 ШТ	
15			1 ШТ	
16		Ø2.8	1 ШТ	

Силиконовый вазелин для фиксации стержня

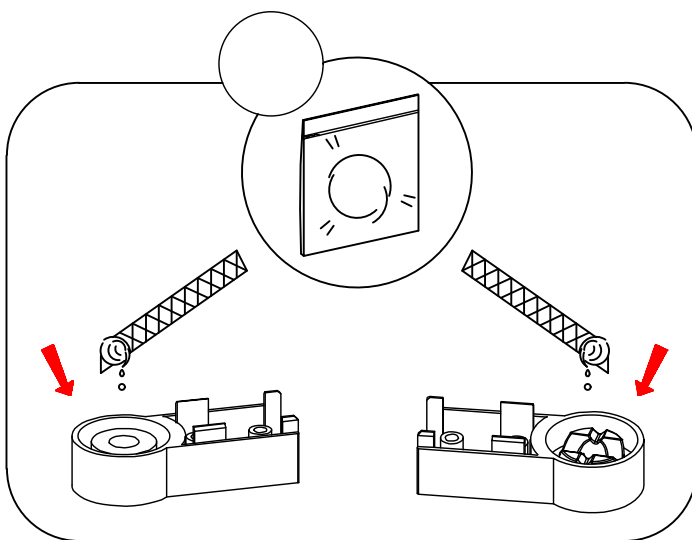

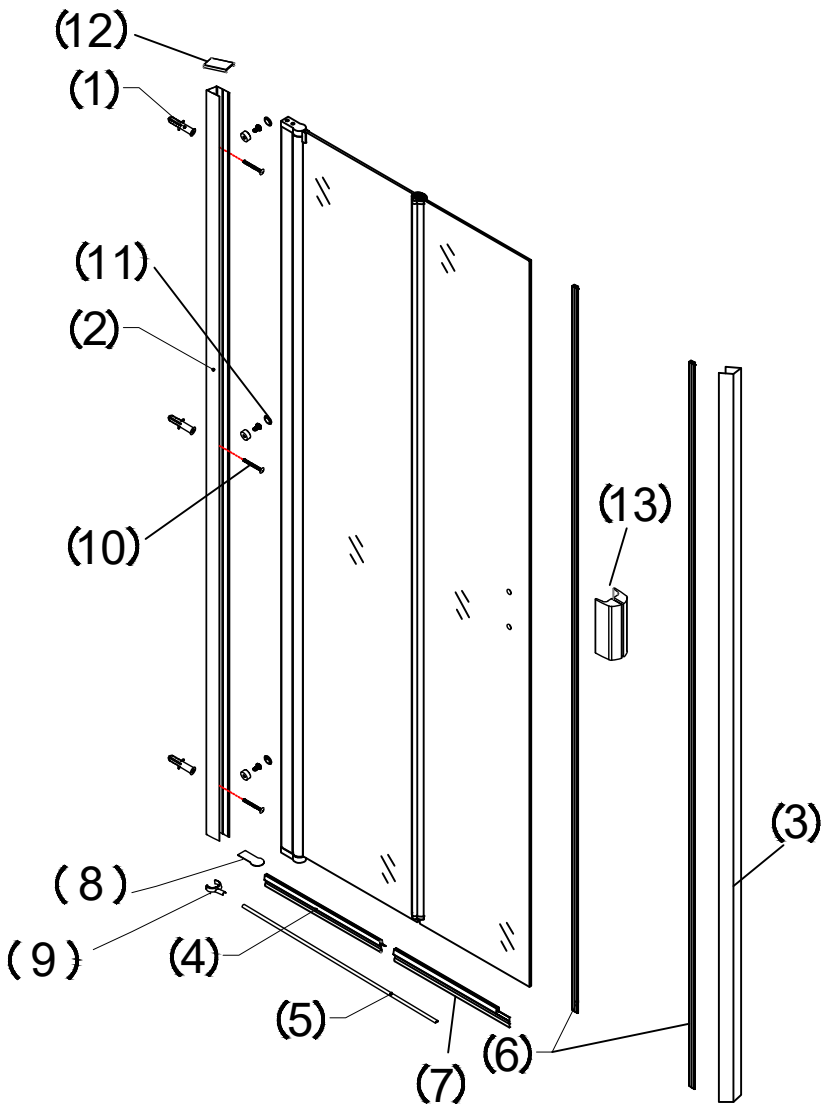

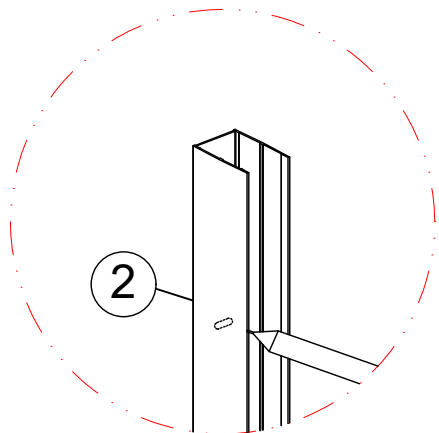

	a
700	685-705
900	885-905
1100	1085-1105

